

ELL-300-E



Installation Instructions

ELL-300-E End of line lamp kit
with cold applied connection technology
for use with BARTEC PSB, MSB, HSB+ or HTSB trace heaters

Origin Installation Instructions

Table of contents	
Overview	2
Certifications / Approvals / Marking	2
Technical data	2
Safety	3
Intended use	3
Foreseeable Misuse	3
Personal Qualification	3
Kit contents	4
Accessories	5
Spare parts	7
Installation	7
Preparation	7
Required tools	8
Cautions and warnings	8
Preparation of the trace heater	9
Installation of the mounting stand	13
Installation of the cable gland	14
Wiring	16
Troubleshooting	18
EC Declaration of conformity	19
Limited Product warranty	21

Overview

This manual introduces the installation of the BARTEC ELL-300-E End of line lamp kit. This kit may be used with one trace heater.

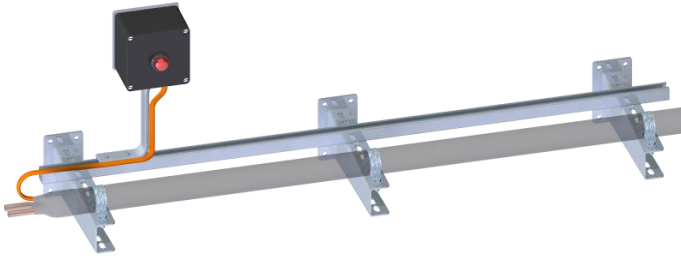

The trace heating system uses a self-regulating trace heater. It features a temperature-dependent resistive heating element that regulates and limits the heat according to the ambient temperature. If the ambient temperature rises, the power output of the trace heater is reduced. This self-regulating property prevents overheating which would cause damage to the trace heater. Crossing or overlapping with other parts of the same trace heating system is also possible.

The trace heaters are fixed equipment heating systems for pipes and tanks in ordinary and hazardous areas. Thanks to the parallel design the trace heater can be cut and installed to any required length (up to the maximum heating circuit length according to the design guide of the trace heating system).

The manual applies for enclosures made of polyester, aluminum and stainless steel material. Pictures in this manual shows polyester enclosures but are equivalent for all materials.

The following terms describe the parts of the trace heater within these instructions:

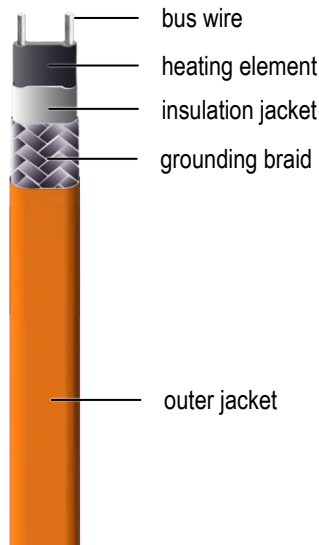

Certifications / Approvals / Marking

System certificate



ELL-300-E End of line lamp kit for BARTEC PSB, MSB trace heaters

IECEX DEK 20.0055X	
	Ex eb 60079-30-1 IIC T6...T3 ¹ Gb Ex tb 60079-30-1 IIIC T80 °C... T170 °C ¹ Db
DEKRA 20ATEX0093 X	
	II 2G Ex eb 60079-30-1 IIC T6...T3 ¹ Gb II 2D Ex tb 60079-30-1 IIIC T80 °C... T170 °C ¹ Db

Enclosure certificate



ELL-300-E End of line lamp kit for BARTEC PSB, MSB, HSB+ or HTSB trace heaters

IECEX DEK 21.0074X	
	Ex eb 60079-30-1 IIC T6...110 °C (T4) ¹ Gb Ex tb 60079-30-1 IIIC T _L 80 °C... T _L 110 °C ¹ Db
DEKRA 21ATEX0118 X	
	II 2G Ex eb 60079-30-1 IIC T6...110 °C (T4) ¹ Gb II 2D Ex tb 60079-30-1 IIIC T _L 80 °C... T _L 110 °C ¹ Db

Technical data

Junction box with mounting stand

Ambient temperature range -55 °C to +40 °C

Min. Installation Temperature -55 °C

Power supply max. 277 Vac

Max. circuit breaker size 32 A

Trace heater output² 10 W/m to 90 W/m

Max. power conductor size 2.5 mm²

Terminals ComEx-module with screw terminals, 2x2 lines; Spring clamp Ex e; 1x3 PE

Ingress Protection IP 64 / IP 66 (IEC 60529)

Connection Technology (CAK)

Min. installation temperature -60 °C

¹ For maximum surface temperature, see heating system design documentation

² nominal heat output at 10 °C

Safety

WARNING

Risk of fire or electrical shock due to electric trace heating system. Follow these guidelines to avoid personal injury or material damage.

For safe installation of the ELL-300-E End of line lamp kit the technical requirements and instructions given in this manual must be followed. Keep these instructions for future reference. If applicable, leave them with the end user.

All electrical systems and installations must comply with BARTEC GmbH requirements and be installed in accordance with the relevant electrical codes and any other applicable national and local codes.

Use the ELL-300-E kit in accordance with the intended use and strictly comply with the operational data specified in section Technical Data.

Install all components of the trace heating system carefully, especially the connection kit, trace heater and end seal.

Any defective component of the kit must be replaced before installation. Replace each defect component of the trace heating system.

This kit contains silicone adhesive. Keep out of reach of children. Store at below 25 °C. Follow the safety instructions given on the packaging.

Use only original BARTEC accessories and spare parts.

Note that the Applicable Documents listed below shows further important information and must be observed in addition to this manual.

Applicable Documents

DesignGuide System (for PSB and MSB)	21-1S00-7D0001
DesignGuide Enclosure (for HSB+ and HTSB)	21-5400-7D0001
Installation Instructions Self-regulating trace heating cables	01-5800-7D0003
Storage conditions	21-0000-7Q0001

Intended use

The ELL-300-E End of line lamp kit is a connection kit including a junction box with mounting stand and connection technology (CAK).

It can be used in trace heating systems combined with BARTEC heating cable types

- BARTEC PSB (07-5853-*)
- BARTEC MSB (07-5854-*)
- BARTEC HSB+ (07-584B-*)
- BARTEC HTSB (07-584C-*)

The kit may only be operated with one heating cable and one kind of heating cable in each heating circuit.

The approval and marking of the respective heating system, the technical data of the ELL-300-E kit and the applicable documents must be observed.

For use with electrical systems, the relevant installation and operating conditions (e.g. according to ATEX Directive 2014/34/EU, EN 60079-0, EN 60079-14, EN 60079-17, EN 60079-30-2 and any other relevant national standards) must be observed.

Specific conditions of use

- Trace heater boxes, Aluminium housing type 07-5180-****/****
The enclosure must not be used in areas affected by charge-producing processes, mechanical friction and separation processes, electron emission (e.g. in the vicinity of electrostatic coating equipment), and pneumatically conveyed dust

Foreseeable Misuse

The following activities are a misuse of the product and are not allowed:

- Use of the ELL-300-E kit for purposes other than those described in the intended use
- Installation, commissioning, operation, maintenance or disposal by unauthorised or unqualified personnel
- Work on live parts or circuits without switching off the ELL-300-E kit or the system
- Commissioning of damaged or faulty system components or incomplete installation
- Unauthorized technical modification of the ELL-300-E kit or its components

Personal Qualification

For system planning, installation, commissioning, operation and maintenance observe the requirements for personnel qualification according to DIN/EN 60079-14, note appendix

Kit contents

The following table lists the kit contents of the ELL-300-E End of line lamp kit:

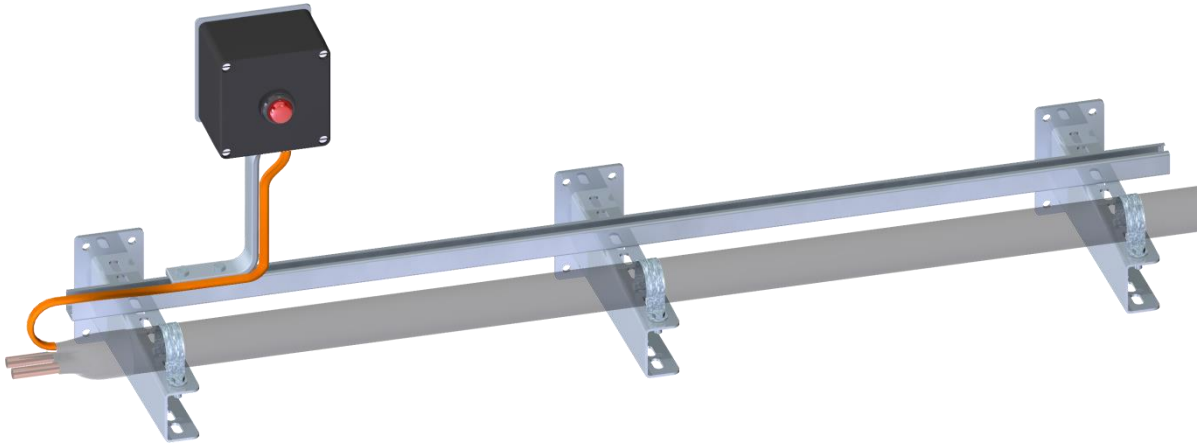

ELL-300-E End of line lamp kit

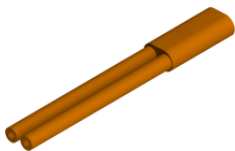

1 x
Silicone pants



1 x
End seal
(in package included, but
not needed for ELL-kits)

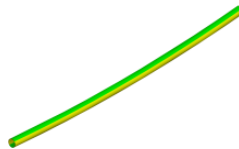

1 x
Green/yellow tube
for grounding braid



1 x
Bonding jumper



3 x
Ferrule
(1.5 mm²)



1 x
Metallic gland body



1 x
"P"-Grommet
for PSB trace heaters



1 x
"H"-Grommet
for MSB trace heaters



1 x
Fixing nut

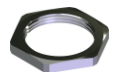

1 x
Lock nut for gland body



1 x
Silicone adhesive



1 x
Cover for junction box
incl. 4 fixing screws



1 x
Junction box with lamp module and
grounding terminal

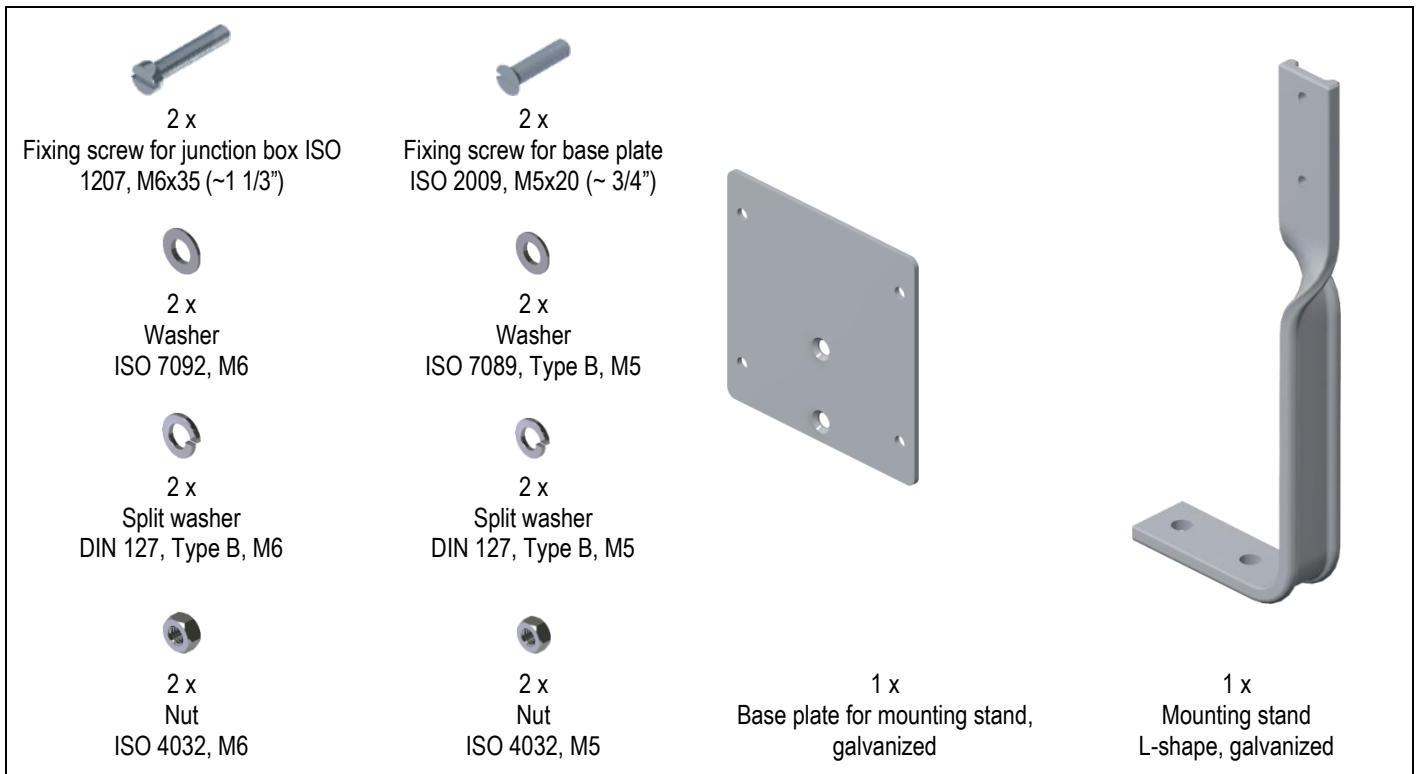

Accessories

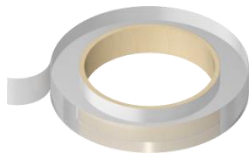

Polyester adhesive tape

Used to fix the heating cable on pipes.

19 mm x 50 m per roll
Maximum withstand temperature: 100 °C

For heating cable PSB.

Gluing below 10 °C should be avoided. Observe processing instructions on datasheet.

Catalog No.: PT-164
Part No.: 02-5500-0005

Tip: Refer to the following table to estimate the required number of tape rolls for your installation:

Pipe diameter in inch (DN)	1/4" (DN8)	1/2" (DN15)	3/4" (DN20)	1" (DN25)	1 1/4" (DN32)	1 1/2" (DN40)	2" (DN50)	2 1/2" (DN65)	3" (DN80)	4" (DN100)	6" (DN150)	8" (DN200)	10" (DN250)	12" (DN300)	14" (DN350)	16" (DN400)	18" (DN450)	20" (DN500)	24" (DN600)
Required no. of tape rolls per 100 ft (30 m) of piping	1	1	1	1	1	1	2	2	2	3	4	5	6	7	7	8	9	10	12

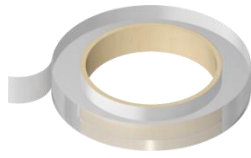

Glass cloth tape

Used to fix the heating cable on pipes.

11 mm x 50 m per roll
 Maximum withstand temperature: 180 °C
 (short term (1h) 250 °C)

For heating cable PSB, MSB, HSB, HSB+, HTSB and EKL Light, EKL Medium and EKL Premium.

Gluing below 10 °C should be avoided. Observe processing instructions on datasheet.

Catalog No.: GT-164
 Part No.: 02-5500-0047

Tip: Refer to the following table to estimate the required number of tape rolls for your installation:

Pipe diameter in inch (DN)	1/4" (DN8)	1/2" (DN15)	3/4" (DN20)	1" (DN25)	1 1/4" (DN32)	1 1/2" (DN40)	2" (DN50)	2 1/2" (DN65)	3" (DN80)	4" (DN100)	6" (DN150)	8" (DN200)	10" (DN250)	12" (DN300)	14" (DN350)	16" (DN400)	18" (DN450)	20" (DN500)	24" (DN600)
Required no. of tape rolls per 100 ft (30 m) of piping	1	1	1	1	1	1	2	2	2	3	4	5	6	7	7	8	9	10	12

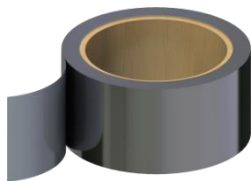

Aluminum adhesive tape

Used to fix the heating cable on pipes.

AT80: 50 mm x 50 m per roll
 AT150: 50 mm x 55 m per roll
 AT230: 50 mm x 50 m per roll

AT80:
 Maximum withstand temperature: 176 °F (80 °C)
 For heating cable PSB

AT150:
 Maximum withstand temperature: 302 °F (150 °C)
 For heating cable MSB, HSB and EKL Light, EKL Medium and EKL Premium

AT230:
 Maximum withstand temperature: 446 °F (230 °C)
 For heating cable HSB+ and HTSB, and EKL Light, EKL Medium and EKL Premium

Gluing below 10 °C should be avoided. Observe processing instructions on datasheet.

AT80:
 Catalog No.: AT80-164
 Part No.: 02-5500-0003
 AT150:
 Catalog No.: AT150-164
 Part No.: 02-5500-0014
 AT230:
 Catalog No.: AT230-164
 Part No.: 02-5500-0043





Electrically traced warning label

Warning label for trace heater circuits

Recommended: electrical warning label every 3 m on the outside of the thermal cladding on a clearly visible place.

German:
 Catalog No.: HTWL-DE
 Part No.: 05-2144-0046
 English:
 Catalog No.: HTWL-EN
 Part No.: 05-2144-0047
 French:
 Catalog No.: HTWL-FR
 Part No.: 05-2144-0703
 Russian:
 Catalog No.: HTWL-RU
 Part No.: 05-2144-0860

	<p>Stainless steel pipe straps</p> <p>Stainless steel, for attaching mounting stands on pipes etc. No special tooling required.</p>	<p>for pipe \varnothing up to DN80: Catalog No: PC-1 Part No.: 03-6510-0228</p> <p>for pipe \varnothing up to DN250: Catalog No: PC-2 Part No.: 03-6510-0229</p>
---	--	--

	<p>Off pipe cable gland kit and end seal</p> <p>CAK-SRG-B with cable gland FG-S-1 for use with heating cable PSB, MSB, HSB+, HTSB</p> <p>CAK-SRG-C with cable gland FG-S-C for use with heating cable PSB, MSB, HSB+, HTSB; cable gland provides adaptor to Conduit system</p>	<p>Catalog No.: CAK-SRG-B with FG-S-1 Part No.: 27-59CX-97010001</p> <p>Catalog No.: CAK-SRG-C with FG-S-C Part No.: 27-59CX-93010001FGSC</p> <p>Other sets available on request.</p>
---	---	---

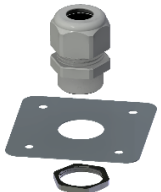
	<p>Insulation entry bushing</p> <p>for protection of trace heaters or sensor cables at the point where they pass through the thermal insulation outer cladding</p>	<p>for PSB trace heaters: Catalog No.: IEB-P Part No.: 05-0020-0472</p> <p>for MSB trace heaters: Catalog No.: IEB-H Part No.: 05-0020-0091</p> <p>for HSB+ and HTSB trace heaters: Catalog No.: IEB-B Part No.: 05-0020-0524</p> <p>for Pt100 M sensor: Catalog No.: IEB-PT Part No.: 05-0020-0262</p>
--	---	---

Spare parts

	<p>Off pipe cable gland kit and end seal</p> <p>Spare parts kit for replacement of damaged or lost parts.</p> <p>CAK-SRG with cable gland TG-*-1 for use with heating cable PSB, MSB</p>	<p>Catalog No.: CAK-SRG with TG-*-1 Part No.: 27-59CX-73010001</p> <p>Other sets available on request.</p>
---	---	--

Installation

Preparation

Before installing any electric trace heating, the person installing must check if the trace heating has been designed and planned correctly. In this regard the instructions of the design guide that comes with each trace heater must be followed. It is particularly essential to verify the following points:

- complete project planning documentation, operating instructions and installation instructions.
- correct selection of the trace heater and accessories with respect to:
 - calculation of heat losses
 - max. permissible operating temperature
 - max. permissible ambient temperature
 - temperature class
 - heating circuit length

Before installing, make sure that all piping and equipment is properly installed and pressure tested.

Required tools

The following tools and equipment are required for installation of the ELL-300-E End of line lamp kit:

- Wire cutters
- Flat screwdriver
- Cross-head screwdriver
- Electricians screwdriver
- Tape measure
- Utility knife
- Needle-nose pliers (2x)
- Adjustable wrenches (2x)
- Crimping pliers



1

Cautions and warnings

⚠ WARNING

Risk of fire or electrical shock due to electric trace heating system.

De-energize all power circuits before installation or servicing. Always use ground fault equipment protection with the trace heating system.

Keep the trace heater ends dry before and during installation. Observe the design guide of the trace heating system.

- Double-check that all power circuits are de-energized before you begin your work.
- Make sure that you do not exceed the maximum heating circuit length for the trace heater type you use.
- Observe the bending radius of each type of trace heater. Do not bend on the narrow axis.
- To avoid short circuits, do not connect the trace heater bus wires together. Installing the End seal properly.
- Keep all components and the trace heaters dry before and during installation.

2

⚠ CAUTION

Risk of injury and/or material damage. Never step on or drive over the trace heater. Do not use it as a loop for stepping on.

- Preferably install the trace heater in a straight line along the pipe. This saves time, helps to avoid installation mistakes and prevents damage to the trace heater during the thermal insulation work.



3

- Preferably install the trace heater in the lower half of the pipe, but not on the lowest point. This prevents mechanical damage and allows for better heat distribution. If you use multiple trace heaters, position them with an offset of 90°.

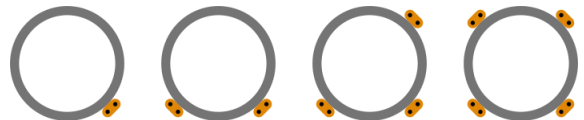

- Mount the mounting stand and junction box preferably on top of the workpiece, e.g. the pipe. If a different orientation of the junction box and mounting stand is necessary, there is a risk of water collecting in the junction box.

Avoid water accumulation in the junction box!

BARTEC recommends applying the pipe insulation immediately after installing the junction box and the mounting stand.

4

Preparation of the trace heater

- For insulated pipes, use an insulation entry bushing to pass the trace heater through the insulation (see section *Accessories* on page 5). Select the insulation entry bushing suitable to the used heating cable.

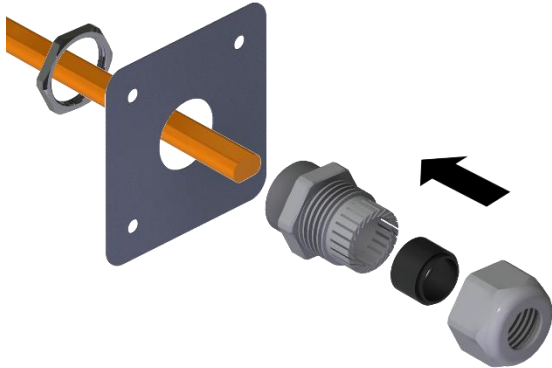

5

- Remove 145 mm of the outer jacket on the end of the trace heater.

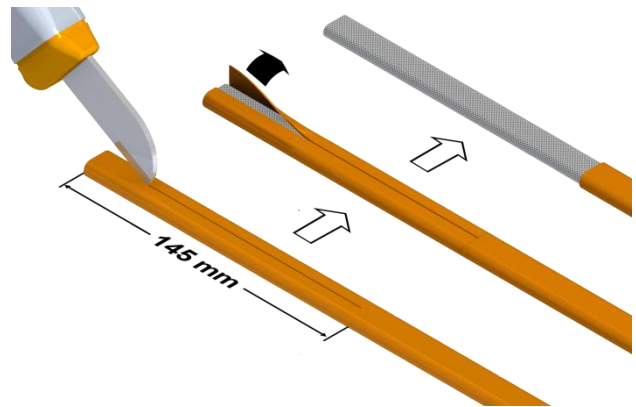

8

- Select the correct grommet for the trace heater to be connected. Note the small letter on the grommet:

- “P”-grommet for PSB trace heaters
- “H”-grommet for MSB trace heaters

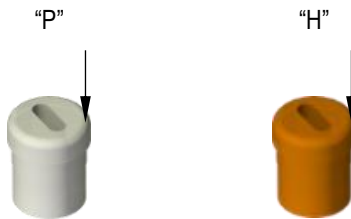

For connection with HSB+ or HTSB trace heater use cold applied kit CAK-SRG-B (not included).

6

- Push the grounding braid back. Use the screwdriver to form an eyelet. Be careful not to damage the internal insulation jacket.

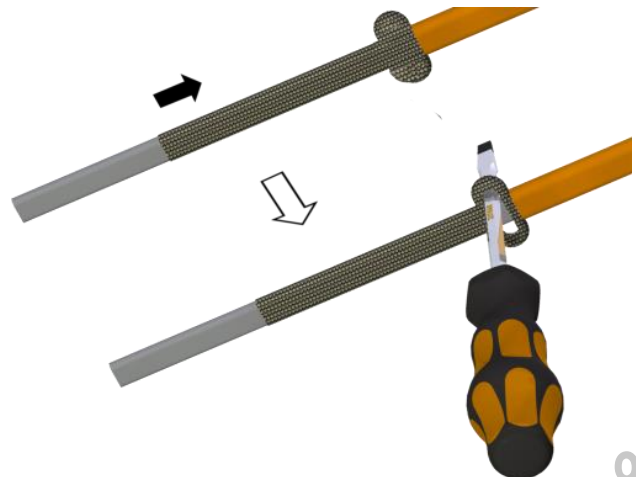

9

- Slide the fixing nut, the grommet and the gland body onto the trace heater.

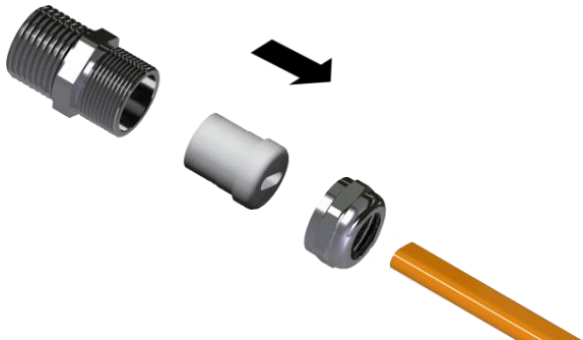

7

- Bend the trace heater and pull the heating element out of the grounding braid.

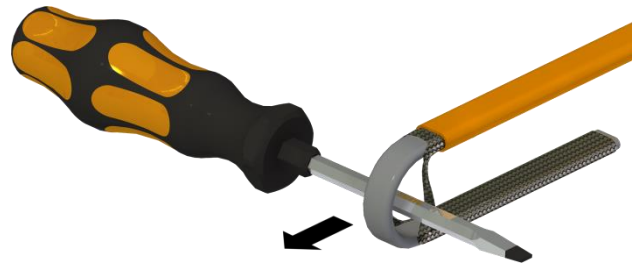

10

- Twist the grounding braid in order to form a pigtail.

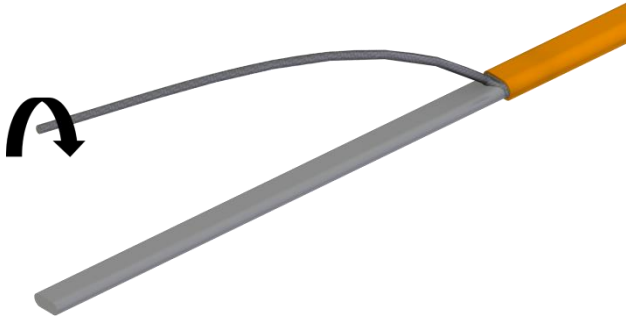

11

- Push the green/yellow tube onto the twisted grounding braid.

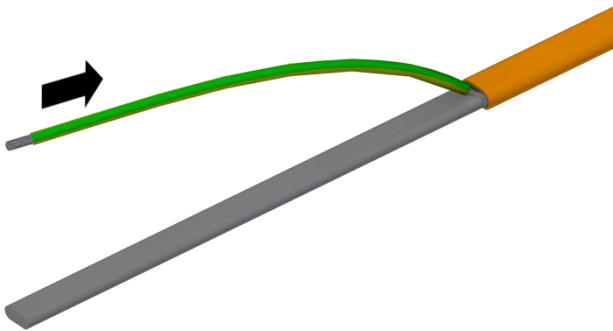

12

- Remove 115 mm of the internal insulation jacket. Take care not to damage the bus wires.

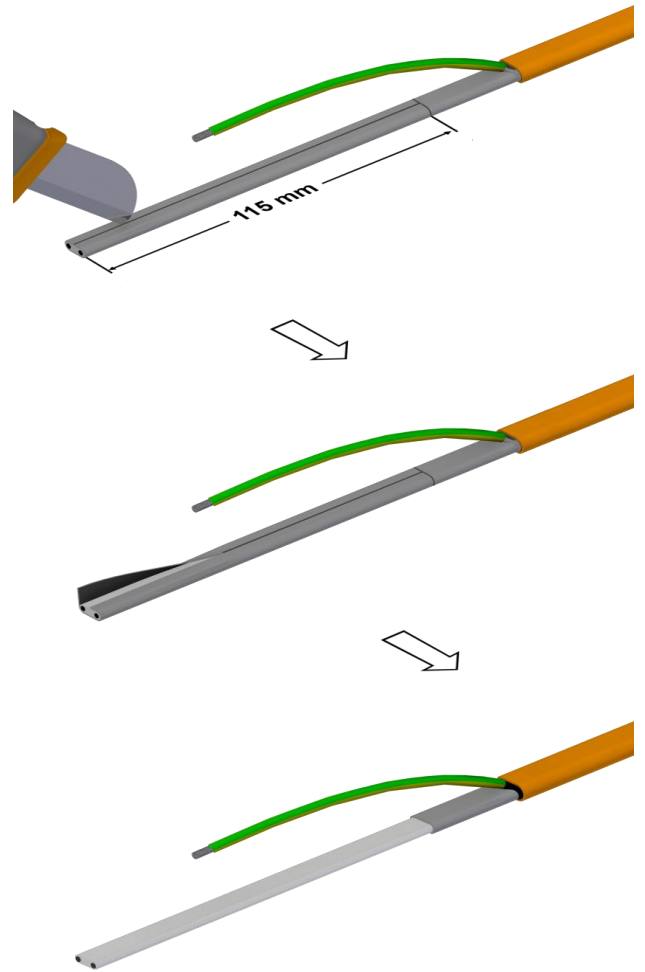

13

- Make a small cut over **and under** each bus wire. Take care not to damage the bus wires.
- Carefully make an incision into the edges of the heating element. Take care not to damage the bus wires.

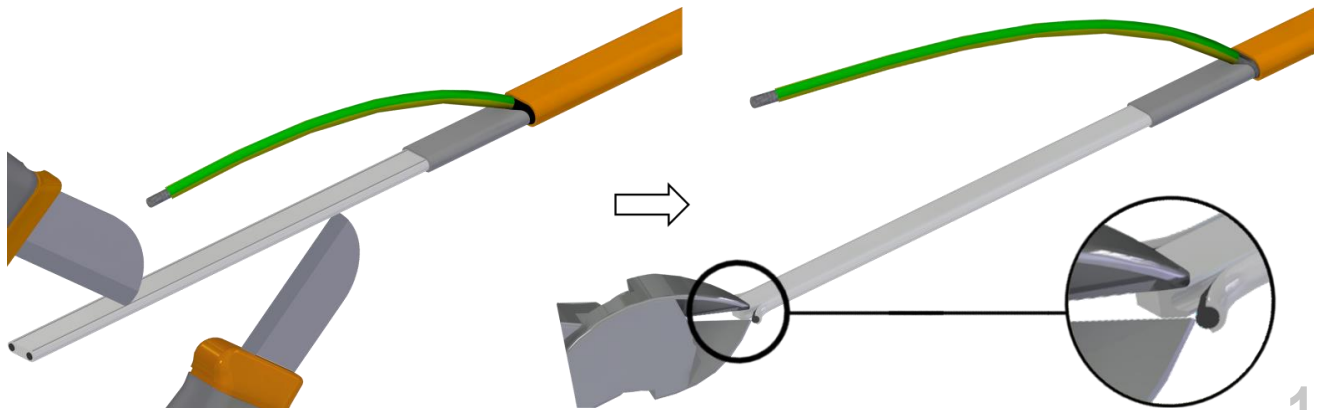

14

- Pull off the bus wires while holding the heating element. Take care not to damage the bus wires.

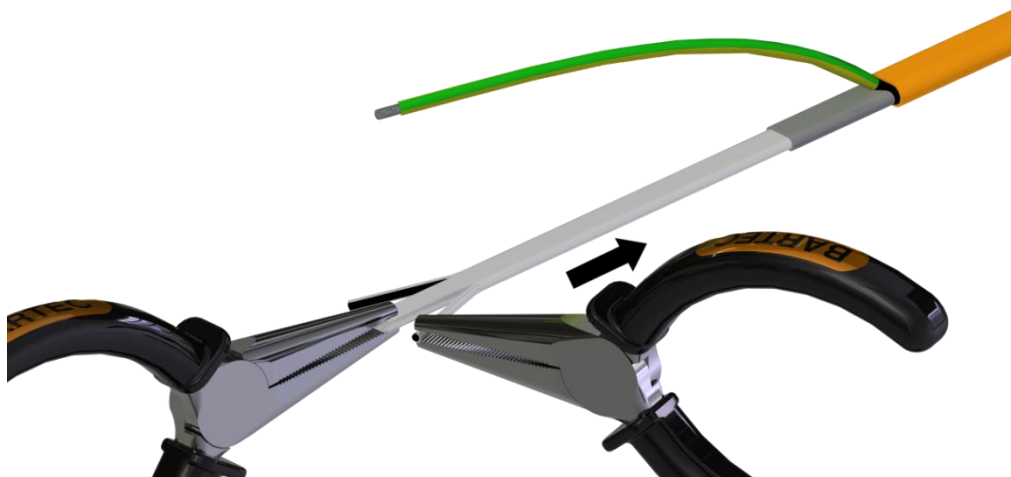

15

- Remove any remaining heating element that sticks to the bus wires.

NOTICE

Risk of malfunction of the heating system. Before you continue, make sure that the bus wires are intact and not nicked or damaged.

- Twist the bus wires.

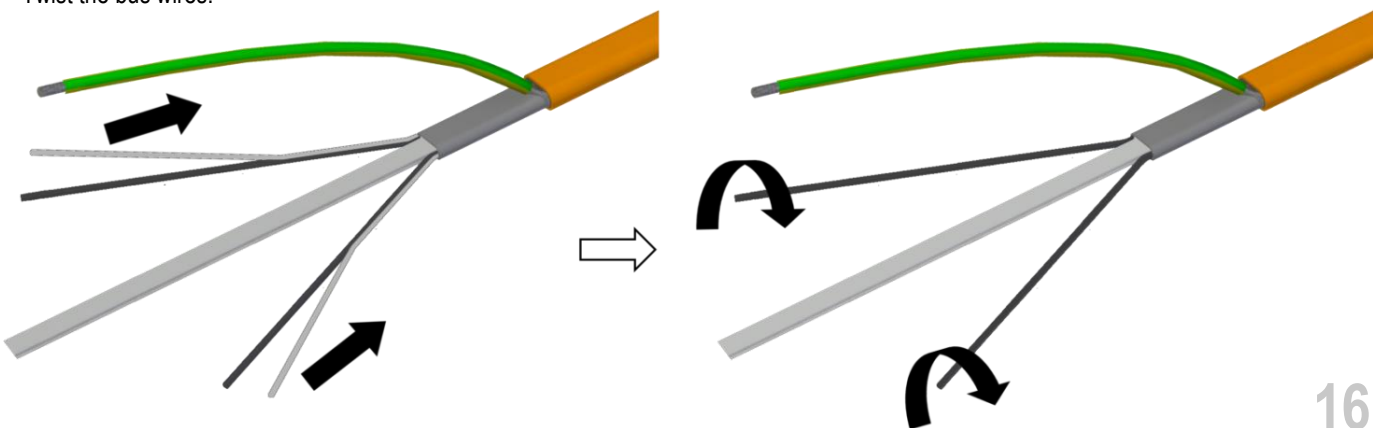

16

- Remove the remaining heating element. Take care not to damage the bus wires.



- Thread the bus wires into the silicone pants.
- You might add further silicone adhesive to ensure optimal sealing.
- Slide the silicone pants all the way onto the heating element.

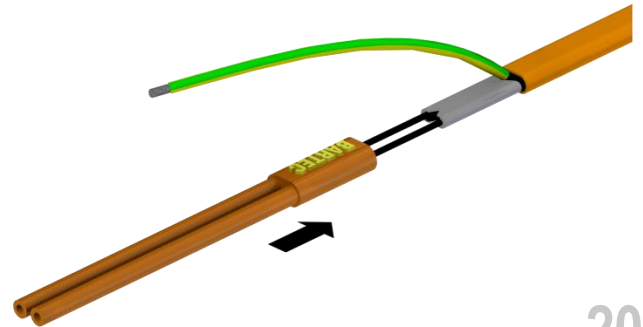

- Carefully cut in a triangle 5 mm between the bus wires. Take care not to damage the bus wires.

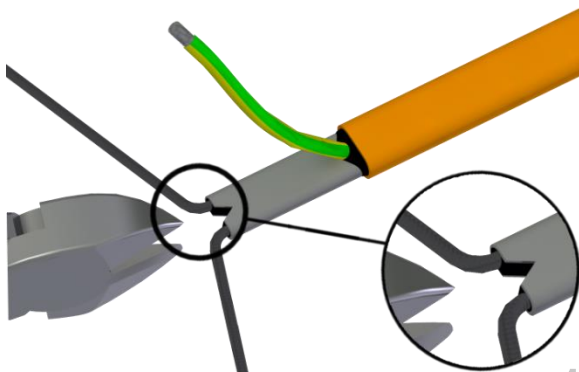

- Optional:
Crimp a ferrule (2.5 mm², not included) onto the twisted grounding braid.

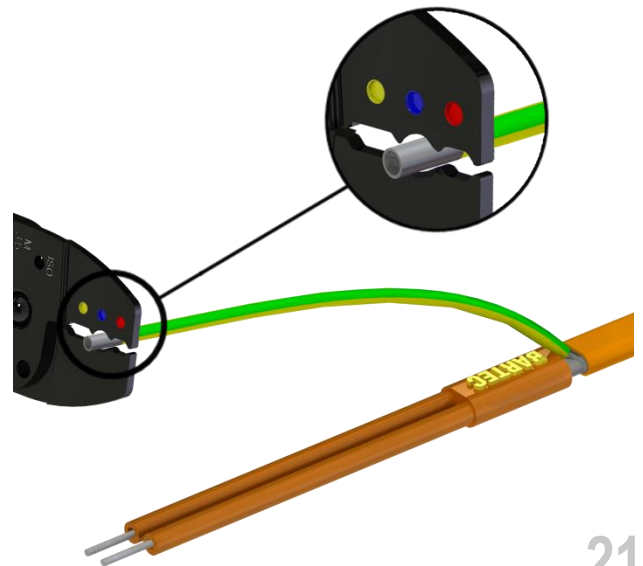

⚠ CAUTION

The silicone adhesive may cause irritation to skin and eyes. Avoid eye contact. Avoid repeated or prolonged skin contact. In case of contact with eyes, rinse with water and seek medical advice.

- Put silicone adhesive onto the exposed heating element and insulation jacket.

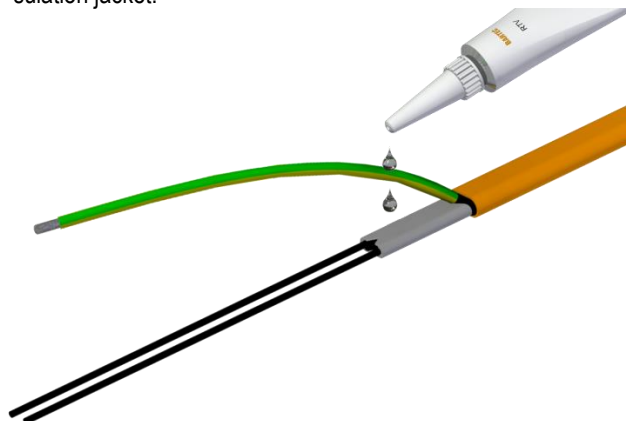

- Crimp a ferrule onto each of the bus wires.

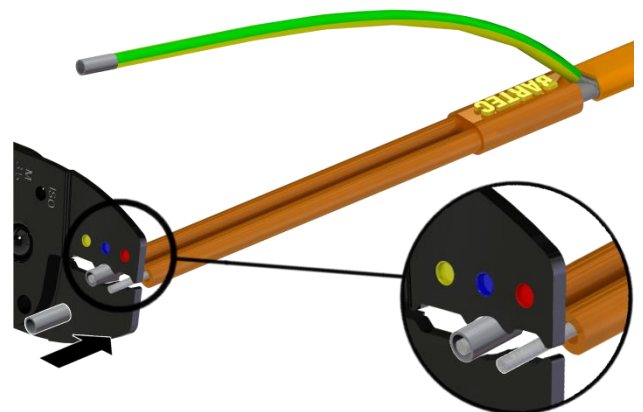

Installation of the mounting stand

- Insert the 2 fixing screws (ISO 2009, M5x20) into the base plate.
- Install the base plate on the mounting bracket.
- Install on each of the 2 fixing screws:
 - a washer (ISO 7089, Type B, M5)
 - a split washer (DIN 127, Type B, M5)
 - a nut (ISO 4032, M5).
- Tighten the screws using a flat screwdriver.

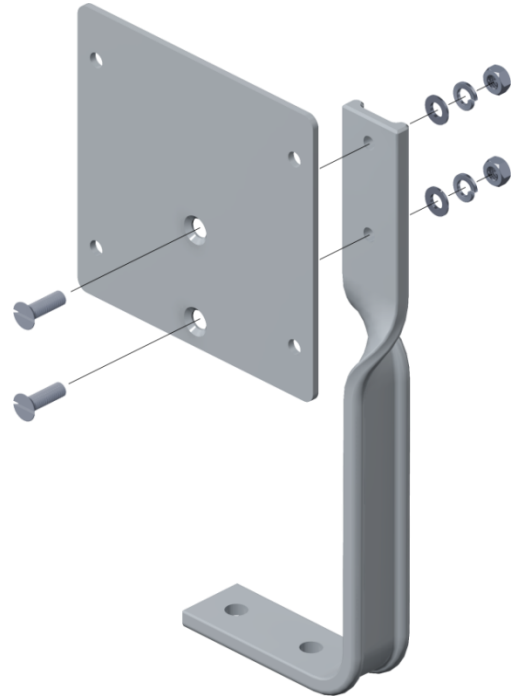

23

- Insert the 2 fixing screws (ISO 1207, M6x35) into the junction box.
- Install the junction box on the base plate.
- Install on each of the 2 fixing screws:
 - a washer (ISO 7092, M6),
 - a split washer (DIN 127, Type B, M6)
 - a nut (ISO 4032, M6).
- Tighten the screws using a flat screwdriver.

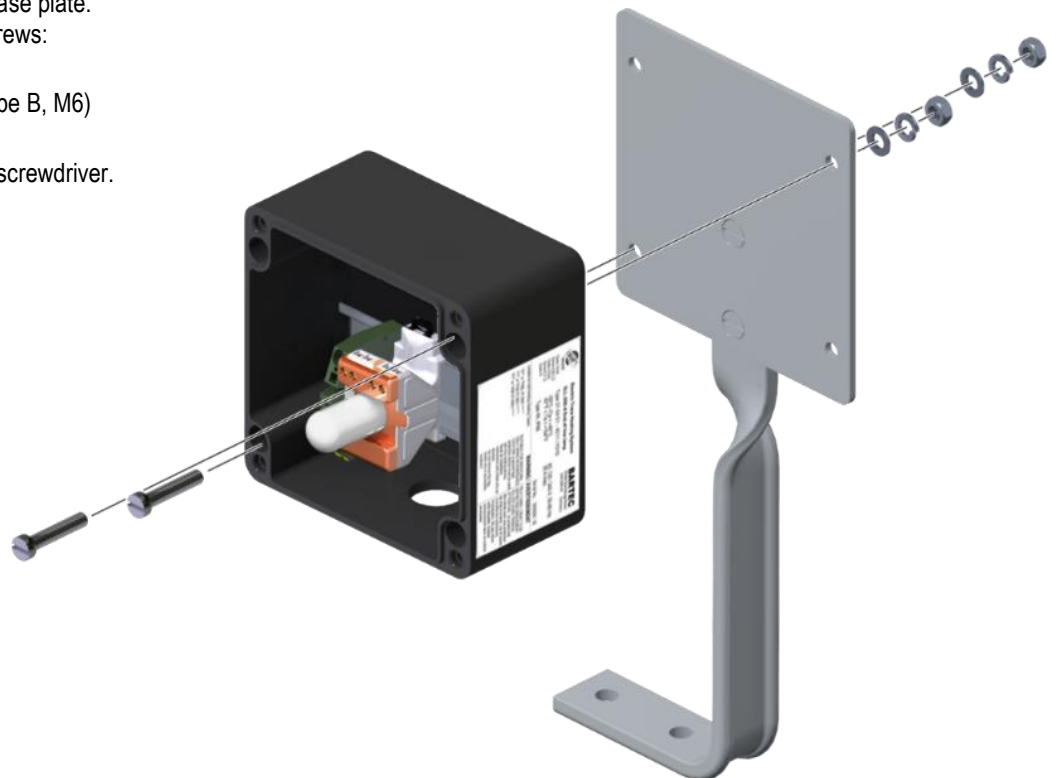

24

- Place the mounting stand on the pipe (or other support) where you want to install it.
- Install the pipe straps and tighten them firmly using a screwdriver.



25

Installation of the cable gland

- Feed the prepared trace heater into the junction box.

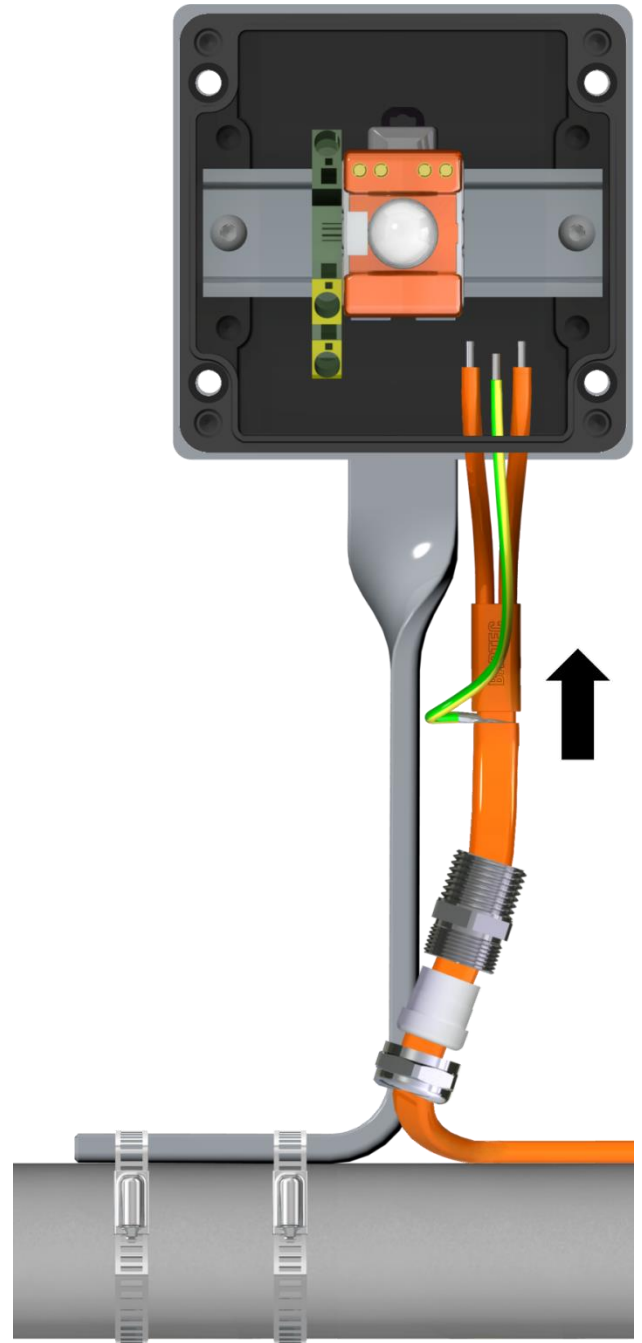

26

- Screw the gland body into the junction box. Observe the indicated torque.
- Slide the bonding jumper and the lock nut onto the gland body.

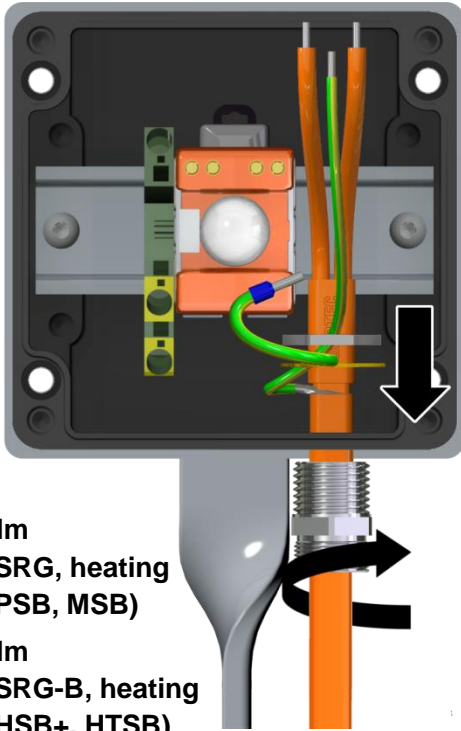

⌧ 10 Nm
 (CAK-SRG, heating
 cable PSB, MSB)
 ⌧ 20 Nm
 (CAK-SRG-B, heating
 cable HSB+, HTSB)

27

- Slide the grommet into the gland body and the fixing nut onto the gland body.

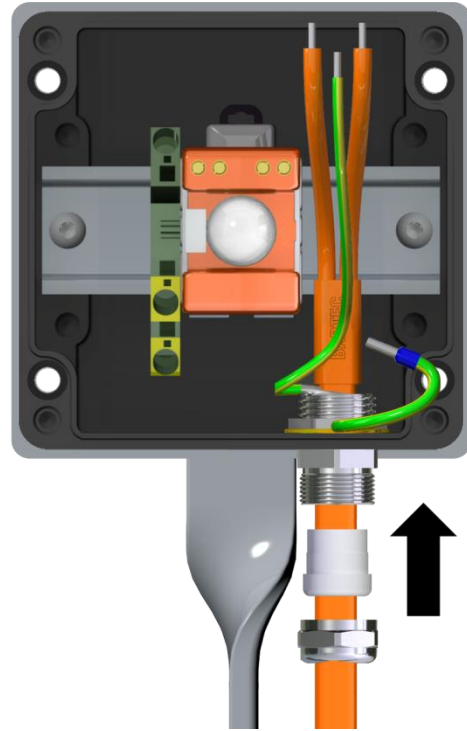

29

- Tighten the lock nut while locking the gland body using 2 adjustable wrenches.

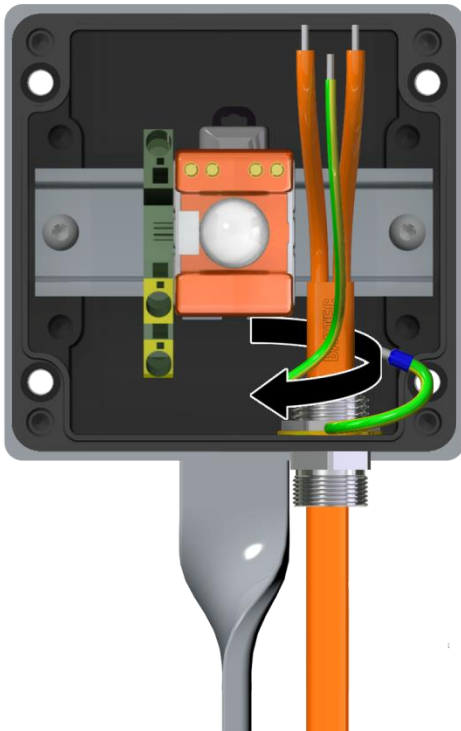

28

- Tighten the fixing nut. Observe the indicated torque.

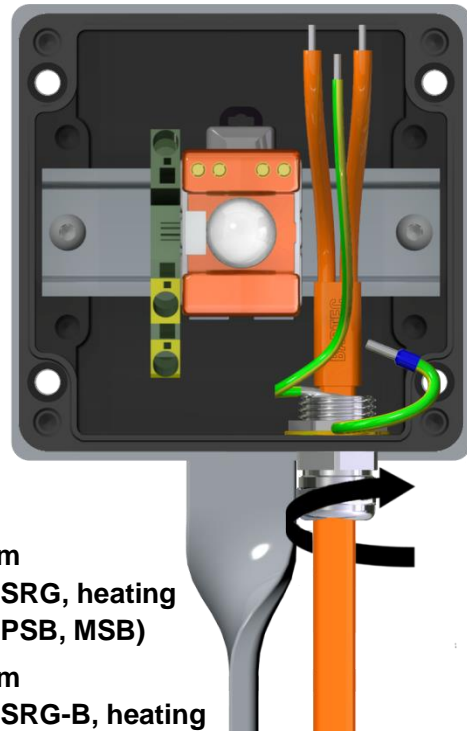

⌧ 2 Nm
 (CAK-SRG, heating
 cable PSB, MSB)
 ⌧ 3 Nm
 (CAK-SRG-B, heating
 cable HSB+, HTSB)

30

Wiring

- For wire connection at the grounding terminal insert a small screwdriver into the screwdriver slot, then insert the wire.
- For wire connection at the lamp module loosen the fixing screw at the terminal, insert the wire and retighten.
- Connect all wires as shown.
- Cover the collar of a ferrule with a tube of the silicone pants

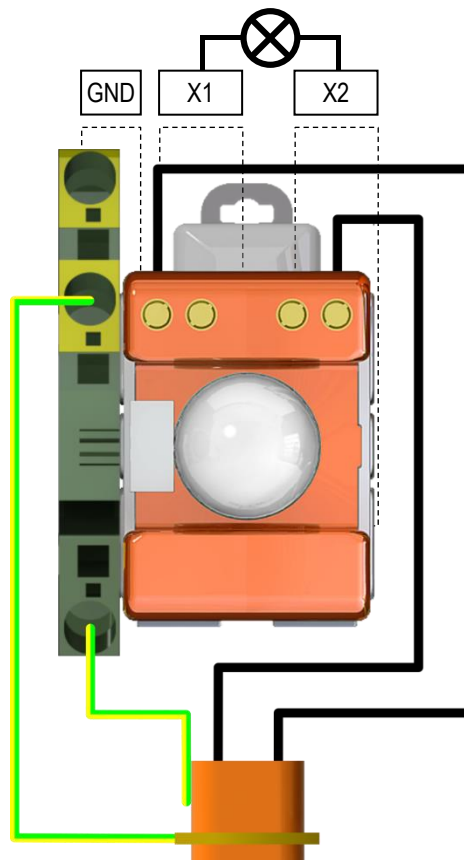
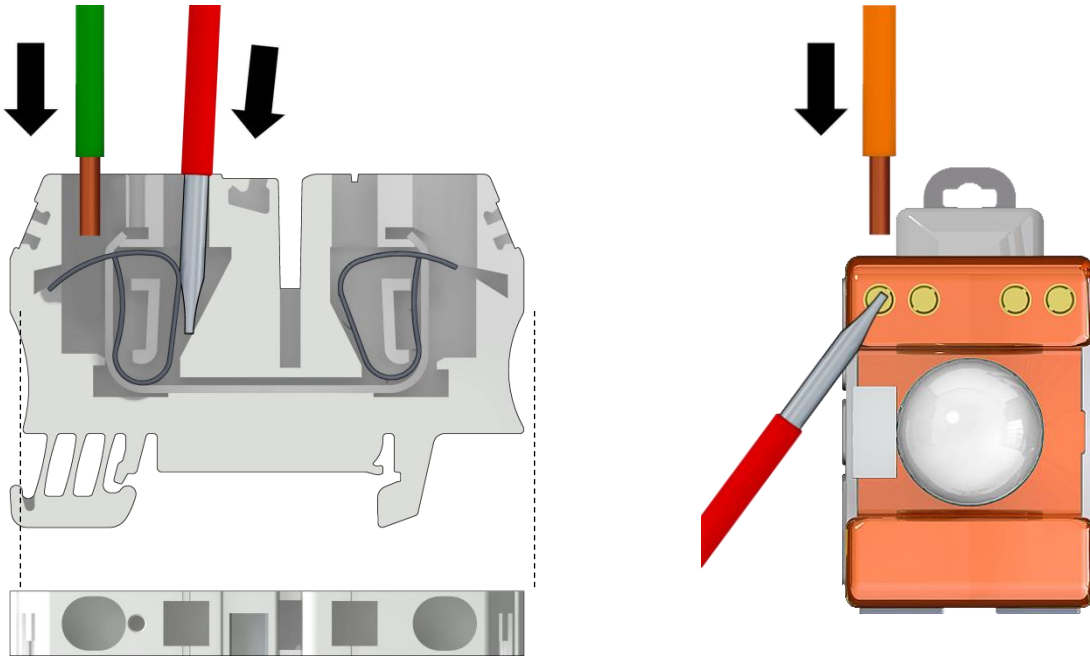

- Mount the cover of the junction box and tighten the 4 fixing screws using a screwdriver.

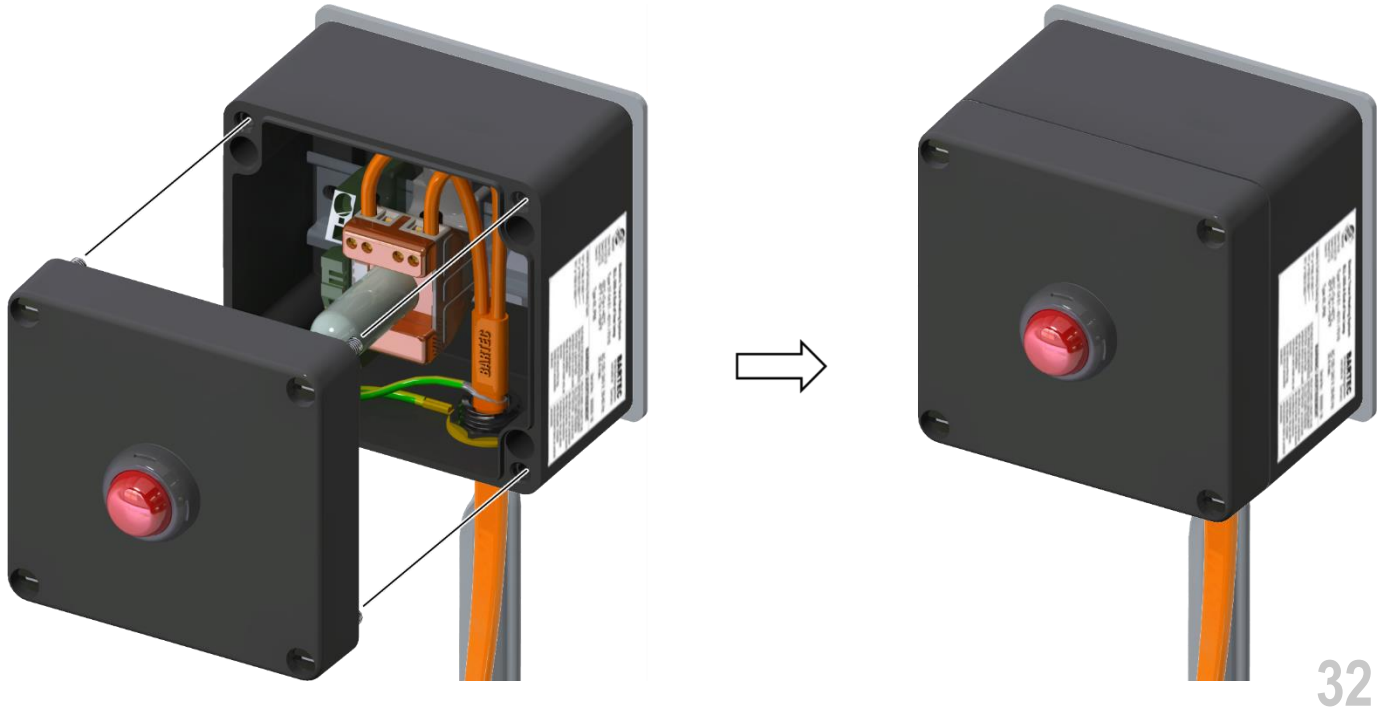

32

- Apply the pipe's insulation according to the manufacturer's installation instructions.
- Apply an electrical warning label every 3 m on a clearly visible place.

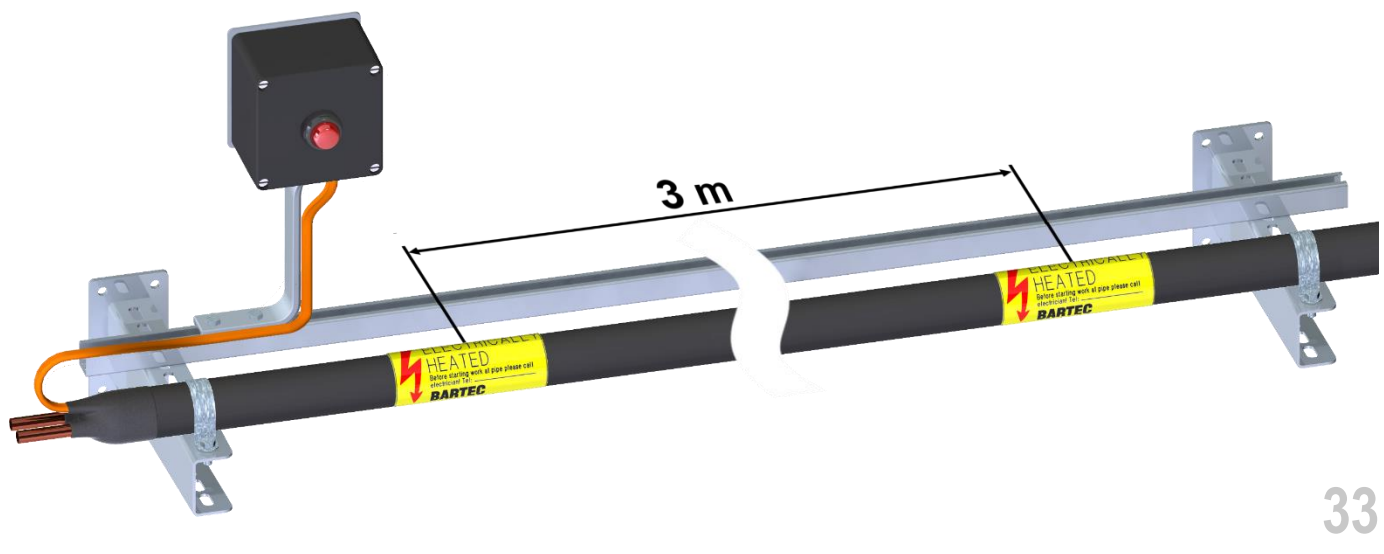

33

NOTICE

Insulation resistance measurement is recommended at certain stages:

- Preliminary test (on the reel, before installation of the trace heater on the construction site)
- Acceptance test (after installation of the heating circuit and before installation of the thermal insulation)
- Final inspection (immediately after completion of work on the thermal insulation)
- Upon commissioning
- Before switching on the installation

Troubleshooting		
Problem	Possible cause	Remedy
Trace heater remains cold	No power supply	Check the supply line
	Trace heater or cold lead cable not properly connected	Connect the trace heater and cold lead cable according to the installation instructions
	Control unit adjusted incorrectly	Adjust the control unit according to the installation instructions
Automatic circuit breaker disengages	Automatic circuit breaker defective	Replace the automatic circuit breaker
	Automatic circuit breaker has wrong tripping characteristics, e. g. "B" instead of "C"	Install an automatic circuit breaker with Type-C tripping characteristics
	Nominal circuit breaker size is insufficient	Install an automatic circuit breaker with higher capacity (Observe the maximum amperage of all components of the trace heating circuit!)
	Maximum heating circuit length has been exceeded	Split the heating circuit into separate circuits
	End seal has not been installed	Install the end seal according to the installation instructions
	Short circuit	Identify the cause and remedy the fault (e. g. ensure that tape tails are not twisted)
Ground fault protection is disengaged	Trace heater damaged	Replace the trace heater at the point where it is damaged
	Moisture in the junction box	Dry the junction box Be sure that the conduit drain is installed and breathing properly.
	Ground fault protection defective	Replace the ground fault protection device(s)

EC Declaration of conformity

EU Konformitätserklärung
 EU Declaration of Conformity
 Déclaration UE de conformité
 N° 21-1S00-7C0001

BARTEC

Wir	We	Nous
-----	----	------

BARTEC GmbH
 Max-Eyth-Straße 16
 97980 Bad Mergentheim
 Germany

erklären in alleiniger Verantwortung, dass das Produkt	declare under our sole responsibility that the product	attestons sous notre seule responsabilité que le produit
PSB / MSB Heizsystem	PSB / MSB Heating system	PSB / MSB Système de Chauffage

Typen 27-1S3*-**/****
 27-1S4*-****/******

auf das sich diese Erklärung bezieht den Anforderungen der folgenden Richtlinien (RL) entspricht	to which this declaration relates is in accordance with the provision of the following directives (D)	se référant à cette attestation correspond aux dispositions des directives (D) suivantes
ATEX-Richtlinie 2014/34/EU	ATEX-Directive 2014/34/EU	Directive ATEX 2014/34/UE
RoHS-Richtlinie 2011/65/EU	RoHS-Directive 2011/65/EU	Directive RoHS 2011/65/UE
EMV-Richtlinie 2014/30/EU	EMC-Directive 2014/30/EU	Directive CEM 2014/30/UE
RED-Richtlinie 2014/53/EU	RED-Directive 2014/53/EU	Directive RED 2014/53/UE
und mit folgenden Normen oder normativen Dokumenten übereinstimmt	and is in conformity with the following standards or other normative documents	et est conforme aux normes ou documents normatifs ci-dessous

EN IEC 60079-0:2018
EN 60079-1 :2014
EN 60079-7:2015/A1:2018
EN 60079-30-1:2017
EN 60079-31:2014
EN 60079-11 :2012
EN 60079-18:2015 + A1 :2017
EN 60529:1991
+ A1:2000 + A2:2013/AC :2019
EN 50495:2010
EN 300328 V2.1.1
EN 62395-1:2013

EN 60947-7-1 :2009
EN 60947-7-2 :2009
EN 60068-2-27 :2009
EN 61000-6-2 :2005
EN61000-6-4 :2007 + A1 :2001
EN 60730-1:2011
EN 60730-2-9:2010
EN 61326-1:2013
EN 61000-4-2:2009
EN 61000-4-3:2006+A1:2007
+A2:2010
EN 61000-4-4:2012
EN 61000-4-5:2014 +A1:2017
EN 61000-4-6:2014
EN 61000-4-8:2010
EN 61000-4-11:2004+A1:2017

Verfahren der EU-Baumusterprüfung / Benannte Stelle	Procedure of EU-Type Examination / Notified Body	Procédure d'examen UE de type / Organisme Notifié
---	--	---

DEKRA 20ATEX0093 X

0344, DEKRA Certification B.V., Meander 1051, 6825 MJ Arnhem, NL

CE 0044

Bad Mergentheim, 22.02.2023

 i.V. Tobias Dold

Head of Business Unit EHT

 i.A. Ulrich Mann

Certification Manager

EU Konformitätserklärung
 EU Declaration of Conformity
 Déclaration UE de conformité
 N° 21-54E2-7C0001



Wir	We	Nous
-----	----	------

BARTEC GmbH
 Max-Eyth-Straße 16
 97980 Bad Mergentheim
 Germany

erklären in alleiniger Verantwortung, dass das Produkt ELL / ELS Anschlussgehäuse und CAK An-/Abschlussstechnik	declare under our sole responsibility that the product ELL / ELS Installation Enclosure and CAK Power-/termination technique	attestons sous notre seule responsabilité que le produit ELL / ELS coffret d'alimentation et CAK Connexion-/termination tech- nique
--	---	--

Typen 27-54E2-**/******
27-59CX-**/******

auf das sich diese Erklärung bezieht den Anforderungen der folgen- den Richtlinien (RL) entspricht ATEX-Richtlinie 2014/34/EU RoHS-Richtlinie 2011/65/EU EMV-Richtlinie 2014/30/EU und mit folgenden Normen oder nor- mativen Dokumenten übereinstimmt	to which this declaration relates is in accordance with the provision of the following directives (D) ATEX-Directive 2014/34/EU RoHS-Directive 2011/65/EU EMC-Directive 2014/30/EU and is in conformity with the following standards or other normative documents	se référant à cette attestation correspond aux dispositions des direc- tives (D) suivantes Directive ATEX 2014/34/UE Directive RoHS 2011/65/UE Directive CEM 2014/30/UE et est conforme aux normes ou docu- ments normatifs ci-dessous
--	---	--

EN IEC 60079-0:2018	EN 60529:1991
EN 60079-7:2015/A1:2018	+ A1:2000 + A2:2013/AC :2019
EN 60079-30-1:2017	EN 60068-2-27 :2009
EN 60079-31:2014	EN 61000-6-2 :2005
EN 60079-1 :2012	EN61000-6-4 :2007 + A1 :2001

Verfahren der EU-Baumuster- prüfung / Benannte Stelle	Procedure of EU-Type Examination / Notified Body	Procédure d'examen UE de type / Organisme Notifié
--	---	--

DEKRA 21ATEX0118 X

0344, DEKRA Certification B.V., Meander 1051, 6825 MJ Arnhem, NL



Bad Mergentheim, 22.02.2023

 i.V. Tobias Dold
 Head of Business Unit EHT

 i.A. Ulrich Mann
 Certification Manager

Limited Product warranty

Scope

BARTEC warrants that all BARTEC products and accessories that are the subject of this manual will be free from defects in materials and workmanship from and after its date of purchase for a period of 12 (twelve) months.

For the avoidance of doubt, this limited product warranty will **not** cover any damage caused by:

- accidents,
- misuse, improper installation, operation, maintenance or repairs,
- neglect, or
- alteration.

Furthermore, BARTEC cannot be held liable under this warranty for:

- installation or removal costs,
- loss or damage to property,
- indirect, special, incidental or consequential damages (including, without limitation, loss of revenue or anticipated profits), or
- any other damages or costs directly or indirectly related to the warranty issue.

If all warranty conditions are met (as set forth below), BARTEC will, at its sole discretion:

- repair the product,
- replace the product, or
- refund the purchase price paid for the product.

This warranty gives you specific legal rights, and you may also have other rights which vary by country, state or province. Except as specifically provided otherwise in this limited product warranty, the BARTEC Group General Terms and Conditions shall apply.

General terms and conditions

- BARTEC Global Terms and conditions are available at: <https://www.bartec.de/en/terms/>

Conditions

- The limited product warranty is subject to the following conditions:
- proper installation, operation and maintenance in compliance with the state of the technology and the product documentation, and
- presence of completely filled in acceptance reports for all installation, maintenance and repairwork operations.

How to claim the warranty

To file a claim under the limited product warranty:

- Notify BARTEC or your local BARTEC representative by written correspondence or email within 30 days after identification of a possible warranty issue.
- If requested, you must provide any warranty-related information and documentation to BARTEC, including, without limitation:
 - project planning documents, and
 - acceptance reports for installation, operation, maintenance or repairwork.

Contact

Bartec GmbH, Max-Eyth-Strasse 16, 97980 Bad Mergentheim

Phone: +49 7931 597-0

Fax: +49 7931 591-499

info@bartec.com

