

## Installation Instructions

### Self-regulating trace heating cables for hazardous / industrial applications



## Installation Instructions

BARTEC Self-regulating trace heating cables  
PSB, MSB, HSB+, HTSB  
for pipes and tanks in hazardous / industrial locations

Origin Installation Instructions



<b>Table of content</b>	
-------------------------	--

<b>Overview</b>	<b>2</b>
Applications	3
Certifications / Approvals / Marking	3
Technical data	3
<b>Safety</b>	<b>4</b>
Intended use	4
Foreseeable Misuse	4
Personal Qualification	4
<b>System design</b>	<b>5</b>
Trace heaters	6
Accessories	7
<b>Installation</b>	<b>10</b>
Preparation	10
Required tools / equipment	10
Cautions and warnings	10
Installation on pipes	10
Unrolling the trace heater	10
Fastening	11
Trace heater routing	11
Installation on tanks and vessels	13
<b>Tests and commissioning</b>	<b>15</b>
Measurement of the insulation resistance	15
Acceptance test and acceptance report	16
Commissioning	16
<b>Operation</b>	<b>16</b>
System documentation	16
<b>Maintenance</b>	<b>16</b>
Visual and functional inspection	16
Electrical inspection	17
Inspection intervals	17
Personnel training courses	17
Repairwork on piping or thermal insulation	17
<b>Troubleshooting</b>	<b>18</b>
<b>Acceptance report / Record of inspection</b>	<b>19</b>
<b>EC Declaration of conformity</b>	<b>20</b>
<b>Limited Product warranty</b>	<b>23</b>

**Overview**

This manual covers the installation and operation of BARTEC Self-regulating trace heating cables for use in hazardous / industrial locations using:

- BARTEC PSB (07-5853-\*)
- BARTEC MSB (07-5854-\*)
- BARTEC HSB+ (07-584B-\*)
- BARTEC HTSB (07-584C-\*)

The self-regulating trace heater features a temperature-dependent resistive element between two parallel copper conductors that regulates and limits the heat output of the trace heater according to the ambient temperature. If the ambient temperature rises, the power output of the trace heater is reduced. This self-regulating property prevents overheating which would cause damage to the trace heater. Even crossing or overlapping with other trace heaters (or other portions of the same trace heater) are possible.

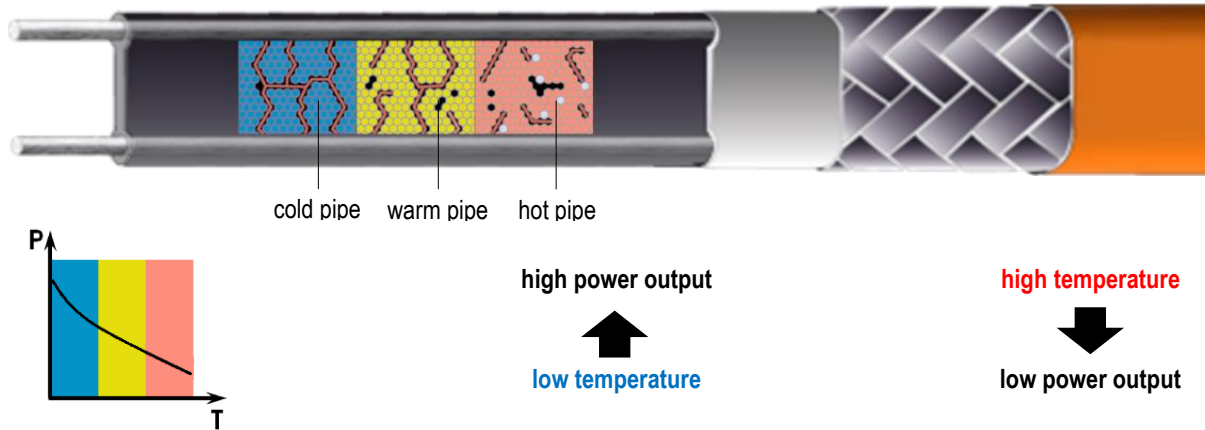

The trace heaters are fixed equipment heating systems for pipes in ordinary and hazardous / industrial areas. Thanks to the parallel design the trace heater can be cut and installed to any required length (up to the maximum heating circuit length as shown the BARTEC Design Guide).

Multiple options for connection, splicing and end termination of the heating circuit are available to meet the individual requirements on site. A large variety of accessories allows for easy customization and extensibility. The following illustration shows a typical electric trace heating system:

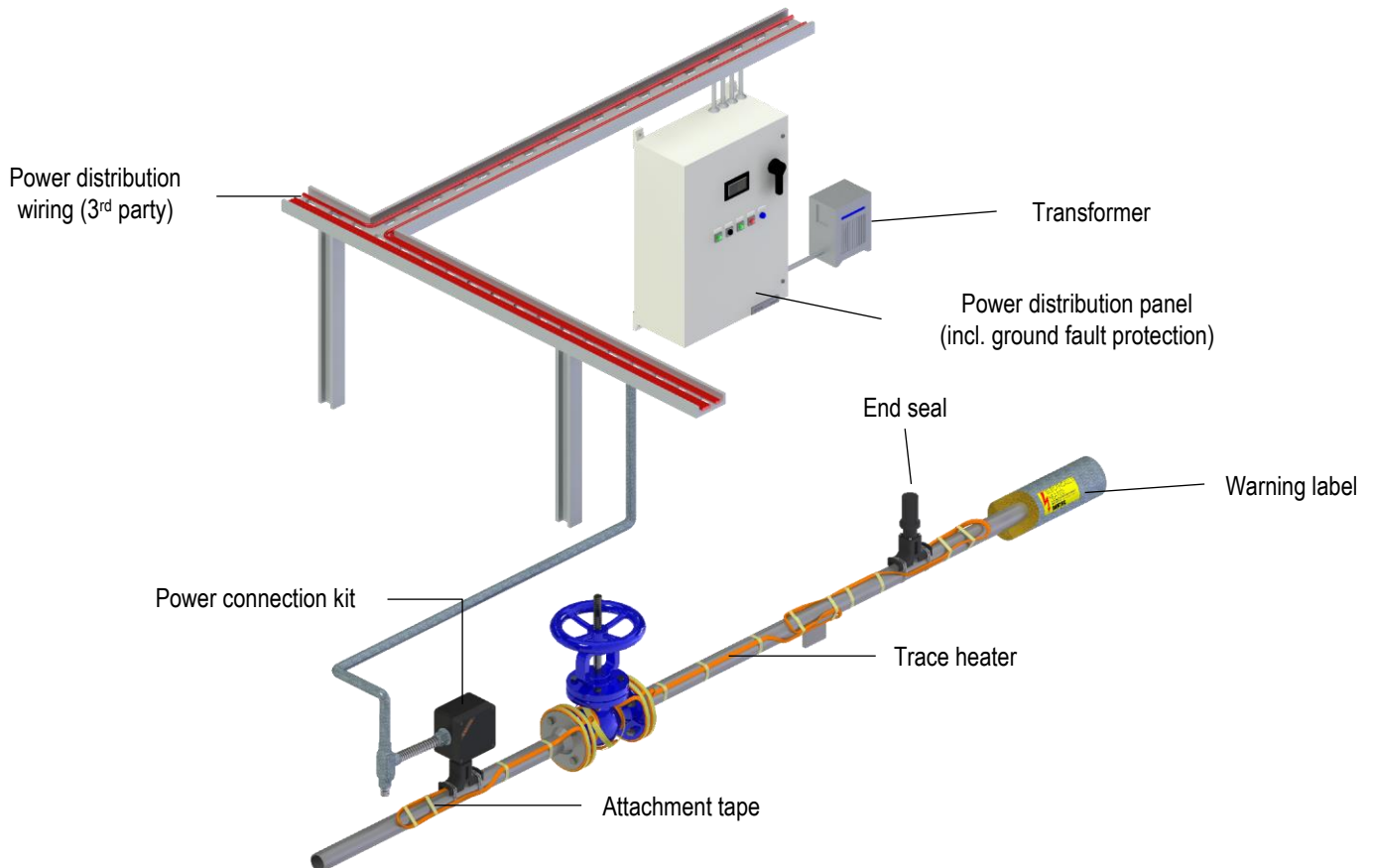

## Applications

Trace heating compensates for the heat loss through the insulation to maintain the pipe and fluid at temperatures above the freezing or solidification point. Thus, trace heating is critical for pipe freeze protection systems that are expected to have stagnant fluids for prolonged durations.

### Freeze protection:

Water, and fluids containing significant water, expand as they freeze. This expansion can cause the pipe to be blocked or break leading to:

- Economic losses: A frozen water pipe leading to a critical process like a frozen pipe in a waste water treatment plant or cooling tower can shut down the operation causing high economic losses.
- Safety issues: A frozen pipe to safety showers can jeopardize personnel safety in the event of hazardous chemical exposure.

### Temperature maintenance:

A process temperature maintenance system can maintain the temperature of the fluid in a pipe to the desired level over a broad range of temperatures.

Maintaining liquids within the specified temperature range allows you to cost-effectively transport the fluids from one location to another, operate your processes at maximum efficiencies, and safely start/shut down your operations.

## Certifications / Approvals / Marking



PSB, MSB	DEKRA 17 ATEX 0007 U IECEX DEK 17.0004U CML21UKEX3983U
HSB+	CML 21ATEX31385 IECEX CML 21.0162 CML 21UKEX31386
HTSB	CML 21ATEX31388 IECEX CML 21.0163 CML 21ATEX31389

## Technical data

	PSB	MSB	HSB+	HTSB
<b>Max. continuous operating temperature, energized</b>	65 °C	110 °C	150 °C	250 °C
<b>Max. continuous exposure temperature, de-energized</b>	85 °C	130 °C	225 °C	250 °C
<b>Min. start-up temperature</b>	-55 °C	-60 °C	-40 °C	-40 °C
<b>Min. installation temperature</b>	-55 °C	-60 °C	-40 °C	-40 °C
<b>Power Output<sup>1</sup></b>	10, 15, 25, 33 W/m	10, 15, 30, 45, 60 W/m	15, 30, 45, 60 W/m	15, 30, 45, 60, 75, 90 W/m
<b>Nominal voltage</b>	110 V to 120 Vac / 208 V to 277 Vac	110 V to 120 Vac / 208 V to 277 Vac	110 V to 120 Vac / 208 V to 277 Vac	110 V to 120 Vac / 208 V to 277 Vac
<b>Max. braid resistance</b>	< 18.2 Ω/km	< 18.2 Ω/km	< 18.2 Ω/km	< 18.2 Ω/km
<b>Braid material</b>	Tinned copper	Nickel-plated copper	Nickel-plated copper	Nickel-plated copper
<b>Min. bending radius</b>	25 mm (Do not bend on the narrow axis.)	10 mm (Do not bend on the narrow axis.)	35 mm (Do not bend on the narrow axis.)	35 mm (Do not bend on the narrow axis.)
<b>Cable weight</b>	13 kg/100 m	11.5 kg/100 m	13.4 kg/100 m	14.6 kg/100 m
<b>Heater dimensions</b>	<i>fluoropolymer outer jacket</i>	11.6 x 5.6 mm	10.2 x 4.8 mm	11.4 x 5.2 mm
	<i>polyolefin outer jacket</i>	11.8 x 5.8 mm	-	-
<b>Temperature classes</b>	T6: 3PSB2, 5PSB2 T5: 8PSB2, 10PSB2	T4: 3MSB2, 5MSB2 T3: 10MSB2, 15MSB2, 20MSB2	T3	T3: 5HTSB2, 10HTSB2, 15HTSB2, 20HTSB2 T2: 25HTSB2, 30HTSB2
<b>Protection classification</b>	⊕ II 2G Ex 60079-30-1 IIC T5, T6 Gb ⊕ II 2D Ex 60079-30-1 IIIC T95 °C, T80 °C Db	⊕ II 2G Ex 60079-30-1 IIC T3, T4, T5, T6 Gb ⊕ II 2D Ex 60079-30-1 IIIC T170 °C, T130 °C, T95 °C, T80 °C Db	⊕ II 2G Ex 60079-30-1 IIC T3 Gb ⊕ II 2D Ex 60079-30-1 IIIC T200 °C Db	⊕ II 2G Ex 60079-30-1 IIC, T2, T3 Gb ⊕ II 2D 60079-30-1 IIIC T200 °C, T300 °C, IP 6x Db

<sup>1</sup> nominal heat output at 10 °C

**Safety****⚠ WARNING**

**Risk of fire or electrical shock due to electric trace heating system. Follow these guidelines to avoid personal injury or material damage.**

For safe installation and operation of BARTEC Self-regulating trace heating cables the technical requirements and instructions given in this manual must be followed. Keep these instructions for future reference. If applicable, leave them with the end user.

All electrical systems and installations must comply with BARTEC GmbH requirements and be installed in accordance with the relevant electrical codes and any other applicable national and local codes.

Use BARTEC Self-regulating trace heating cables in accordance with the intended use and strictly comply with the operational data specified in section Technical Data. Install all components of the trace heating system carefully.

Any defective component of the trace heating system must be replaced before installation. Replace each defect component of the trace heating system.

Use only original BARTEC accessories and spare parts.

Note that the Applicable Documents listed below shows further important information and must be observed in addition to this manual.

**Applicable Documents**

DesignGuide System (for PSB and MSB)	21-1S00-7D0001
DesignGuide Enclosure (for HSB+ and HTSB)	21-5400-7D0001
Storage conditions	21-0000-7Q0001

**Intended use**

BARTEC Self-regulating trace heating cables types

- BARTEC PSB (07-5853-\*)
- BARTEC MSB (07-5854-\*)
- BARTEC HSB+ (07-584B-\*)
- BARTEC HTSB (07-584C-\*)

are designed for industrial purposes in trace heating systems for freeze protection and temperature maintenance applications. It is intended for use in hazardous (potentially explosive) / industrial gas or combustible dust atmospheres. BARTEC Self-regulating trace heating cables can be combined with defined BARTEC splice kits and junction boxes.

Operation is allowed with one kind of heating cable in each heating circuit only.

Verification is required for the installation of heating cables on plastic pipes. Please contact your local BARTEC distributor for verification.

The design of the heating cable must not exceed the maximum permissible temperature of the pipe material.

Also, adjustments in heat loss calculations may be required.

The approval and marking of the respective heating system, the technical data of the BARTEC Self-regulating trace heating cables and the applicable documents must be observed.

For use with electrical systems, the relevant installation and operating conditions (e.g. according to ATEX Directive 2014/34/EU, EN 60079-0, EN 60079-14, EN 60079-17, EN 60079-30-2 and any other relevant national standards) must be observed.

**Foreseeable Misuse**

The following activities are a misuse of the product and are not allowed:

- Use of the BARTEC Self-regulating trace heating cables for purposes other than those described in the intended use
- Installation, commissioning, operation, maintenance or disposal by unauthorised or unqualified personnel
- Work on live parts or circuits without switching off the BARTEC Self-regulating trace heating cables or the system
- Commissioning of damaged or faulty system components or incomplete installation
- Unauthorized technical modification of the BARTEC Self-regulating trace heating cables

**Personal Qualification**

For system planning, installation, commissioning, operation and maintenance observe the requirements for personnel qualification according to DIN/EN 60079-14, note appendix A.

## System design

For the design of trace heating systems with BARTEC Self-regulating trace heating cables, the following steps are necessary:

- Trace heater selection
- Determination of the total required trace heater length
- Determination of the required number of trace heating circuits
- Selection of the required components and accessories for power connection, control and monitoring, end termination etc.





For a detailed description on how to design a self-regulating heating system, see

DesignGuide System (for PSB and MSB) 21-1S00-7D0001

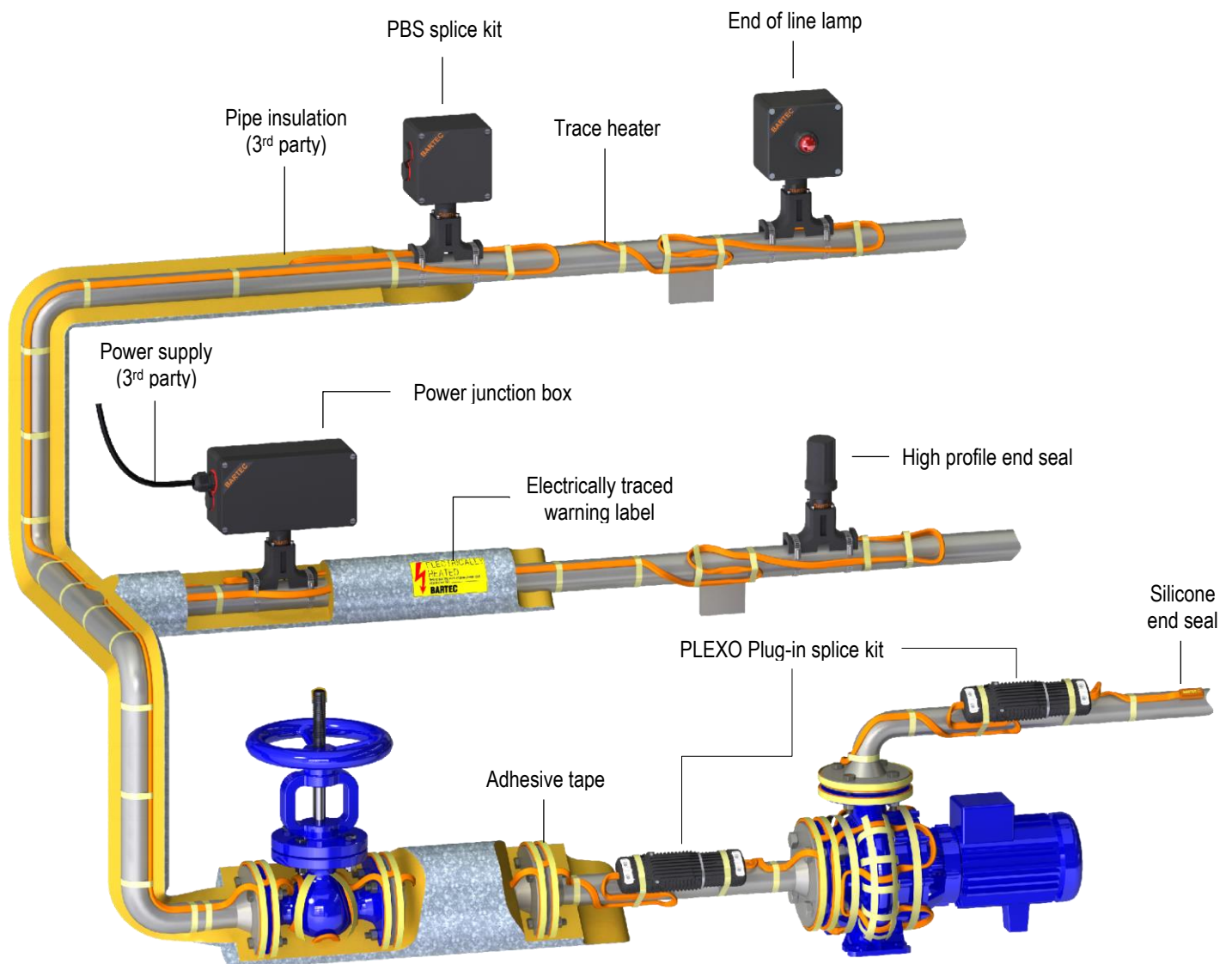
DesignGuide Enclosure (for HSB+ and HTSB) 21-5400-7D0001

The following figure shows a sample heating circuit including typical components:



Trace heaters					
	<p><b>PSB trace heater with polyolefin outer jacket</b></p> <p>Self-regulating trace heater for installation on pipes, tanks etc.</p> <p><i>Polyolefin outer jacket: suitable for exposure to aqueous chemicals</i></p> <p><i>Approved for Zone 1/21 and Zone 2/22 areas. See data sheet for full details.</i></p>	120 Vac	Catalog No.:	Order No.:	Part No.:
		10 W/m	3PSB1-CR	439493	07-5853-110P
		15 W/m	5PSB1-CR	439494	07-5853-115P
		25 W/m	8PSB1-CR	439495	07-5853-125P
		33 W/m	10PSB1-CR	439496	07-5853-133P
		230 Vac	Catalog No.:	Order No.:	Part No.:
		10 W/m	3PSB2-CR	439497	07-5853-710P
		15 W/m	5PSB2-CR	439498	07-5853-715P
		25 W/m	8PSB2-CR	439499	07-5853-725P
		33 W/m	10PSB2-CR	439500	07-5853-733P
	<p><b>PSB trace heater with fluoropolymer outer jacket</b></p> <p>Self-regulating trace heater for installation on pipes, tanks etc.</p> <p><i>Fluoropolymer outer jacket: suitable for exposure to organic chemicals</i></p> <p><i>Approved for Zone 1/21 and Zone 2/22 areas. See data sheet for full details.</i></p>	120 Vac	Catalog No.:	Order No.:	Part No.:
		10 W/m	3PSB1-CT	439501	07-5853-110F
		15 W/m	5PSB1-CT	439502	07-5853-115F
		25 W/m	8PSB1-CT	439503	07-5853-125F
		33 W/m	10PSB1-CT	439504	07-5853-133F
		230 Vac	Catalog No.:	Order No.:	Part No.:
		10 W/m	3PSB2-CT	439505	07-5853-710F
		15 W/m	5PSB2-CT	439506	07-5853-715F
		25 W/m	8PSB2-CT	439507	07-5853-725F
		33 W/m	10PSB2-CT	439508	07-5853-733F
	<p><b>MSB trace heater</b></p> <p>Self-regulating trace heater for installation on pipes, tanks etc.</p> <p><i>Fluoropolymer outer jacket: suitable for exposure to organic chemicals</i></p> <p><i>Approved for Zone 1/21 and Zone 2/22 areas. See data sheet for full details.</i></p>	120 Vac	Catalog No.:	Order No.:	Part No.:
		10 W/m	3MSB1-CT	439509	07-5854-110F
		15 W/m	5MSB1-CT	439510	07-5854-115F
		30 W/m	10MSB1-CT	439511	07-5854-130F
		45 W/m	15MSB1-CT	439512	07-5854-145F
		60 W/m	20MSB1-CT	439513	07-5854-160F
		230 Vac	Catalog No.:	Order No.:	Part No.:
		10 W/m	3MSB2-CT	439514	07-5854-710F
		15 W/m	5MSB2-CT	439515	07-5854-715F
		30 W/m	10MSB2-CT	439516	07-5854-730F
		45 W/m	15MSB2-CT	439517	07-5854-745F
		60 W/m	20MSB2-CT	439518	07-5854-760F
	<p><b>HSB+ trace heater</b></p> <p>Self-regulating trace heater for installation on pipes, tanks etc.</p> <p><i>Fluoropolymer outer jacket: suitable for exposure to organic chemicals</i></p> <p><i>Approved for Zone 1/21 and Zone 2/22 areas. See data sheet for full details.</i></p>	120 Vac	Catalog No.:	Order No.:	Part No.:
		15 W/m	5HSB+1-CT	400821	07-584B-115F
		30 W/m	10HSB+1-CT	400822	07-584B-130F
		45 W/m	15HSB+1-CT	400823	07-584B-145F
		60 W/m	20HSB+1-CT	400824	07-584B-160F
		230 Vac	Catalog No.:	Order No.:	Part No.:
		15 W/m	5HSB+2-CT	400825	07-584B-715F
		30 W/m	10HSB+2-CT	400826	07-584B-730F
		45 W/m	15HSB+2-CT	400827	07-584B-745F
		60 W/m	20HSB+2-CT	400828	07-584B-760F



	<b>HTSB trace heater</b>	<b>120 Vac</b>	<b>Catalog No.:</b>	<b>Order No.:</b>	<b>Part No.:</b>
	Self-regulating trace heater for installation on pipes, tanks etc.	15 W/m	5HTSB1-CT	400829	07-584C-115F
	Fluoropolymer outer jacket: suitable for exposure to organic chemicals	30 W/m	10HTSB1-CT	400830	07-584C-130F
	Approved for Zone 1/21 and Zone 2/22 areas.	45 W/m	15HTSB1-CT	400831	07-584C-145F
	See data sheet for full details.	60 W/m	20HTSB1-CT	400832	07-584C-160F
		75 W/m	25HTSB1-CT	400833	07-584C-175F
		90 W/m	30HTSB1-CT	400834	07-584C-190F
		<b>230 Vac</b>	<b>Catalog No.:</b>	<b>Order No.:</b>	<b>Part No.:</b>
		15 W/m	5HTSB2-CT	400835	07-584C-715F
		30 W/m	10HTSB2-CT	400836	07-584C-730F
	45 W/m	15HTSB2-CT	400837	07-584C-745F	
	60 W/m	20HTSB2-CT	400838	07-584C-760F	
	75 W/m	25HTSB2-CT	400839	07-584C-775F	
	90 W/m	30HTSB2-CT	400840	07-584C-790F	

**Accessories**

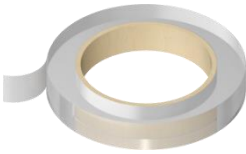
	<b>Polyester adhesive tape</b>	<b>Catalog No.:</b> PT-164
	Used to fix the heating cable on pipes.	<b>Part No.:</b> 02-5500-0005
	19 mm x 50 m per roll Maximum withstand temperature: 100 °C	
	For heating cable PSB. Gluing below 10 °C should be avoided. Observe processing instructions on datasheet.	

Tip: Refer to the following table to estimate the required number of tape rolls for your installation:

Pipe diameter in inch (DN)	1/4" (DN8)	1/2" (DN15)	3/4" (DN20)	1" (DN25)	1 1/4" (DN32)	1 1/2" (DN40)	2" (DN50)	2 1/2" (DN65)	3" (DN80)	4" (DN100)	6" (DN150)	8" (DN200)	10" (DN250)	12" (DN300)	14" (DN350)	16" (DN400)	18" (DN450)	20" (DN500)	24" (DN600)
Required no. of tape rolls per 100 ft (30 m) of piping	1	1	1	1	1	1	2	2	2	3	4	5	6	7	7	8	9	10	12

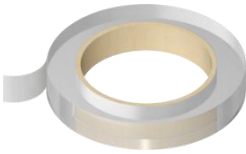
	<b>Glass cloth tape</b>	<b>Catalog No.:</b> GT-164
	Used to fix the heating cable on pipes.	<b>Part No.:</b> 02-5500-0047
	11 mm x 50 m per roll Maximum withstand temperature: 180 °C (short term (1h) 250 °C)	
	For heating cable PSB, MSB, HSB, HSB+, HTSB and EKL Light, EKL Medium and EKL Premium. Gluing below 10 °C should be avoided. Observe processing instructions on datasheet.	

Tip: Refer to the following table to estimate the required number of tape rolls for your installation:

Pipe diameter in inch (DN)	1/4" (DN8)	1/2" (DN15)	3/4" (DN20)	1" (DN25)	1 1/4" (DN32)	1 1/2" (DN40)	2" (DN50)	2 1/2" (DN65)	3" (DN80)	4" (DN100)	6" (DN150)	8" (DN200)	10" (DN250)	12" (DN300)	14" (DN350)	16" (DN400)	18" (DN450)	20" (DN500)	24" (DN600)
Required no. of tape rolls per 100 ft (30 m) of piping	1	1	1	1	1	1	2	2	2	3	4	5	6	7	7	8	9	10	12

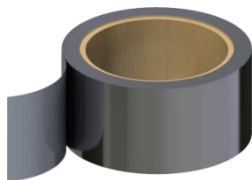
	<p><b>Aluminum adhesive tape</b></p> <p>Used to fix the heating cable on pipes.</p> <p>AT80: 50 mm x 50 m per roll              AT150: 50 mm x 55 m per roll              AT230: 50 mm x 50 m per roll</p> <p>AT80:              Maximum withstand temperature: 176 °F (80 °C)              For heating cable PSB</p> <p>AT150:              Maximum withstand temperature: 302 °F (150 °C)              For heating cable MSB, HSB and EKL Light, EKL Medium and EKL Premium</p> <p>AT230:              Maximum withstand temperature: 446 °F (230 °C)              For heating cable HSB+ and HTSB, and EKL Light, EKL Medium and EKL Premium</p> <p>Gluing below 10 °C should be avoided. Observe processing instructions on datasheet.</p>	<p>AT80:              Catalog No.: AT80-164              Part No.: 02-5500-0003</p> <p>AT150:              Catalog No.: AT150-164              Part No.: 02-5500-0014</p> <p>AT230:              Catalog No.: AT230-164              Part No.: 02-5500-0043</p>
---	--	---

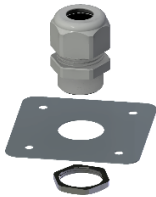
	<p><b>Insulation entry bushing</b></p> <p>for protection of trace heaters or sensor cables at the point where they pass through the thermal insulation outer cladding</p>	<p>for PSB trace heaters:              Catalog No.: IEB-P              Part No.: 05-0020-0472</p> <p>for MSB trace heaters:              Catalog No.: IEB-H              Part No.: 05-0020-0091</p> <p>for HSB+ and HTSB trace heaters:              Catalog No.: IEB-B              Part No.: 05-0020-0524</p> <p>for Pt100 M sensor:              Catalog No.: IEB-PT              Part No.: 05-0020-0262</p>
--	---	---

	<p><b>Electrically traced warning label</b></p> <p>Warning label for trace heater circuits</p> <p>Recommended: electrical warning label every 3 m on the outside of the thermal cladding on a clearly visible place.</p>	<p>German:              Catalog No.: HTWL-DE              Part No.: 05-2144-0046</p> <p>English:              Catalog No.: HTWL-EN              Part No.: 05-2144-0047</p> <p>French:              Catalog No.: HTWL-FR              Part No.: 05-2144-0703</p> <p>Russian:              Catalog No.: HTWL-RU              Part No.: 05-2144-0860</p>
---	--	---

**Polyester fixing straps**

for installation of trace heaters on tanks and vessels

*for tank diameters up to 2 m*

*16 mm x 850 m on full roll*

Catalog No.: PFS-850

Part No.: 03-6500-0100

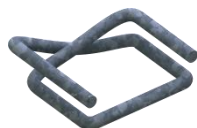
**Tensioning buckle**

for use with the PFS-850 polyester fixing straps

Catalog No.: TB-075

Part No.: 03-6515-0203

**Installation**

**Preparation**

Before installing any electric trace heating, the person installing must check if the trace heating has been designed and planned correctly. It is particularly essential to verify the following points:

- complete project planning documentation, operating instructions and installation instructions.
- correct selection of the trace heater and accessories with respect to:
  - calculation of heat losses
  - max. permissible operating temperature
  - max. permissible ambient temperature
  - temperature class
  - heating circuit length

Before installing, make sure that all piping and equipment is properly installed and pressure tested.

**Required tools / equipment**

The following tools are required for installation of the BARTEC Self-regulating trace heating systems:

- Wire cutters
- Insulation resistance meter with a minimum testing voltage of 500 Vdc and a maximum testing voltage of 2500 Vdc.



1

**Installation on pipes**

This step is necessary for plastic pipes only since plastic pipes conduct heat less efficiently than metal pipes do. For metal pipes continue with step 4.

- Place aluminium tape where the trace heater will be attached for better heat distribution.



2

**Unrolling the trace heater**

- Unroll the required trace heater in a straight line and cut to the correct length. Cut off the trace heater ensuring a straight cut.

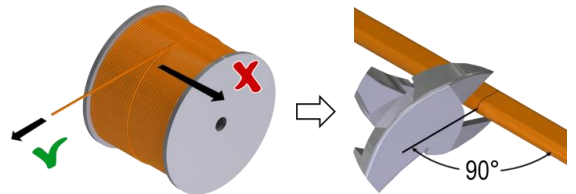

3

**Cautions and warnings**

**⚠ WARNING**

**Risk of fire or electrical shock due to electric trace heating system. De-energize all power circuits before installation or servicing. Always use ground fault equipment protection with the trace heating system. Keep the trace heater ends dry before and during installation. Observe the design guide of the trace heating system.**

- Double-check that all power circuits are de-energized before you begin your work.
- Make sure that you do not exceed the maximum heating circuit length for the trace heater type you use.
- Observe the bending radius of each type of trace heater. Do not bend on the narrow axis.
- To avoid short circuits, do not connect the trace heater bus wires together. Installing the End seal properly.
- Keep all components and the trace heaters dry before and during installation.
- Do not bend or pinch the trace heater, or pull it over sharp edges.
- Risk of injury and/or material damage. Never Step on or drive over the trace heater. Do not use it as a loop for Stepping on.

- Install the trace heater in a straight line along the pipe. This saves time, helps to avoid installation mistakes and prevents damage to the trace heater during the thermal insulation work.



- Preferably install the trace heater in the lower half of the pipe, but not on the lowest point. This prevents mechanical damage and allows for better heat distribution.
- If you use multiple trace heaters, position them with an offset of 90°.

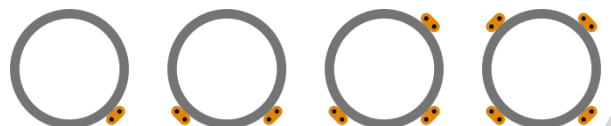

4

## Fastening

Select the correct fastening material:

- Use polyester adhesive tape or glass cloth tape that suits the expected temperatures.
- Preferably use BARTEC adhesive tapes.
- Never use PVC electrical tape or self-adhesive tapes containing PVC or VC.
- Do not use metal wire or banding.



5

- Fasten the trace heater with the adhesive tape at intervals of max. 300 mm on plastic pipes or 900 mm on steel pipes.

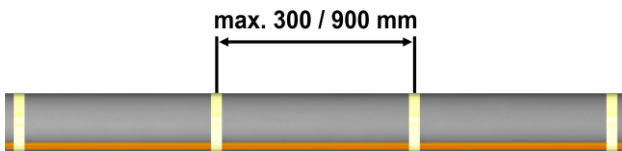

## NOTICE

In order to ensure good heat transmission the trace heater must have a flat, flush fit over the whole length. If necessary, reduce the distances between the fixing points.

6

- Apply the pipe's insulation according to the manufacturer's installation instructions.
- Apply an electrical WARNING label every 3 m on a clearly visible place.

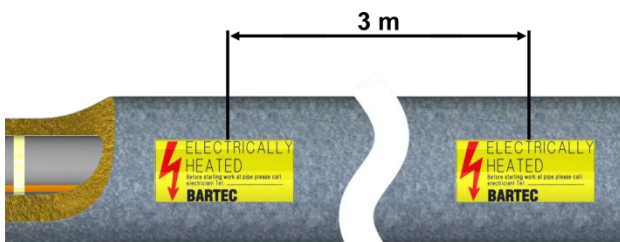

7

## Trace heater routing

- On fittings, valves etc. you should leave a sufficiently large trace heater loop to ensure that the equipment is easily accessible. This way, heating circuits do not have to be cut up for maintenance or replacement works.
- Due to the higher heat losses from fittings, valves, flanges etc. an additional length of trace heater is required. This requirement is specified in the project planning documents.
- The following illustrations show typical types of installation.

## NOTICE

Observe the bending radius of each type of trace heater. See Technical data. Do not bend on the narrow axis.

8

- Installation on bends:

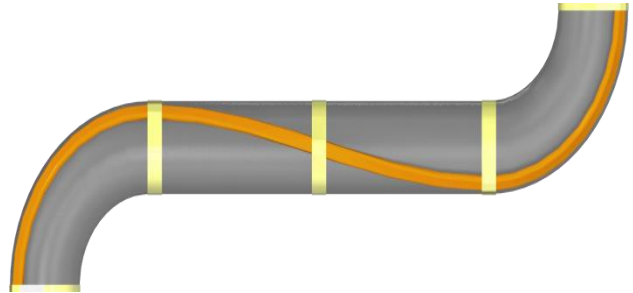

9

- Installation of service loops on components:

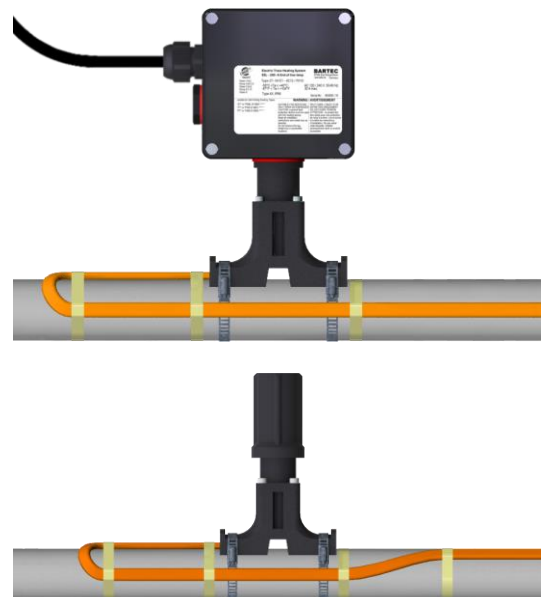

10

- Installation on valves:

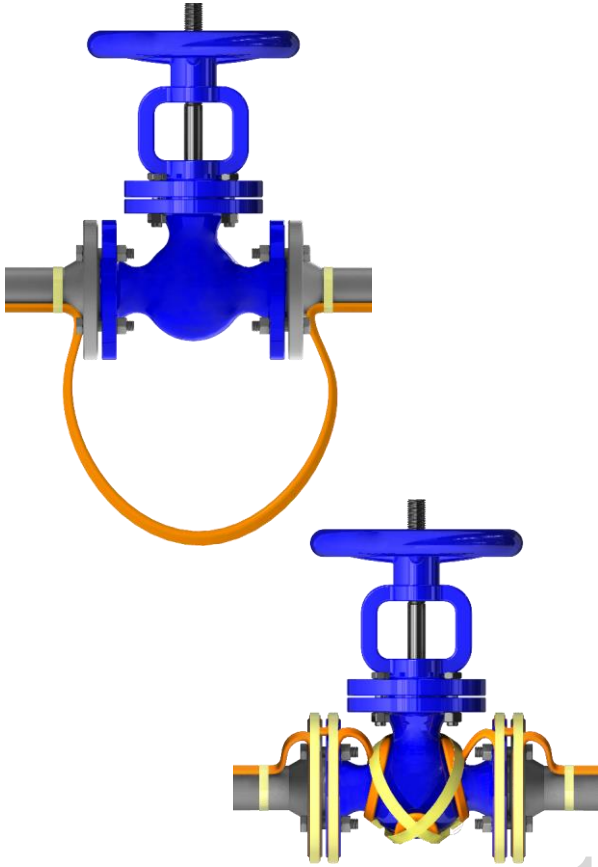

11

- Installation on pipe supports:

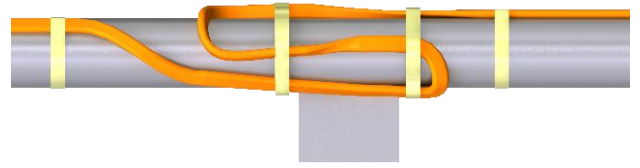

13

- Installation on pressure gauges:



14

- Installation on flanges:

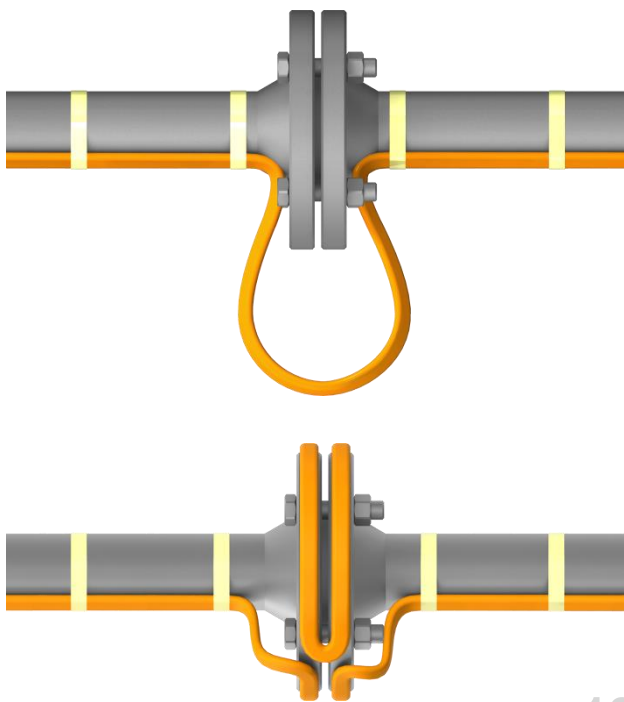

12

- Installation on pumps:

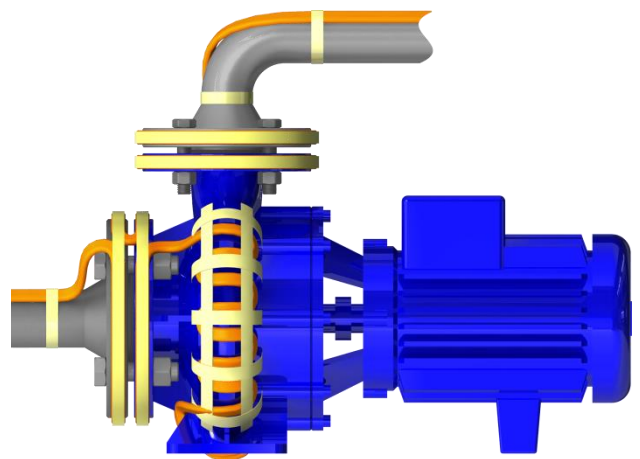

15

**Installation on tanks and vessels**

- For tank diameters of up to 2 m the trace heater is attached using polyester fixing straps and tensioning buckles.



- To fasten the fixing straps thread the polyester straps through the tensioning buckle as shown and pull the ends of the straps.

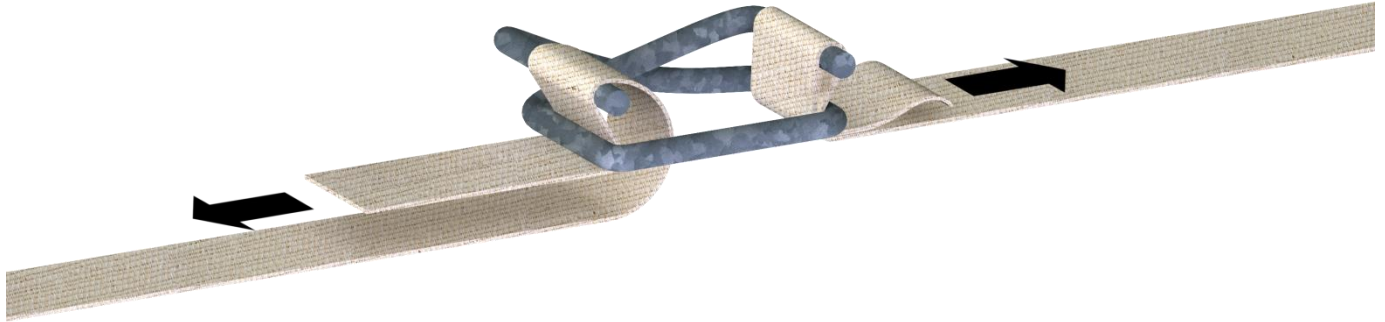

16

- At first, install fixing straps around the beginning and end of the tank and fasten them with slight tension.

**Upright tank**



**Horizontal tank**

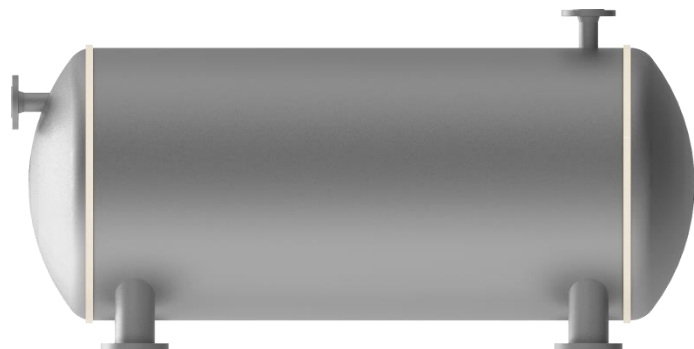

17



- Install the trace heater beginning at the supply point.
- Fix it at the distances specified in the project planning documentation. Use the pre-mounted fixing straps to hold the trace heaters in place.
- Allow for material addition for the bases.

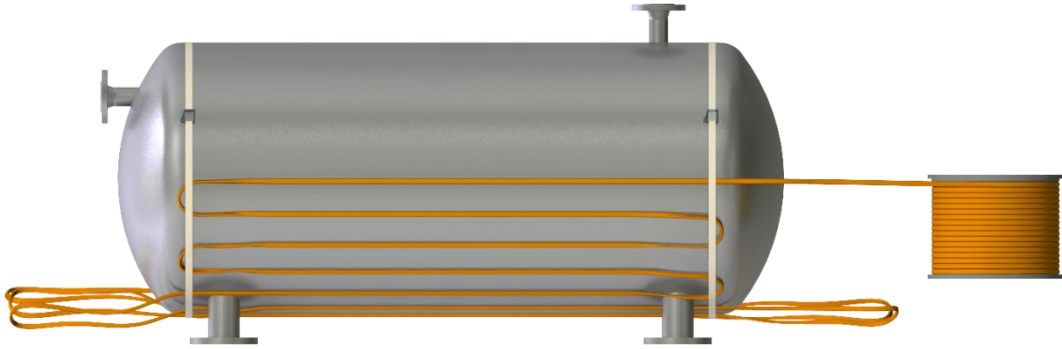

18

- Align the trace heater exactly and fix it firmly to the bases and the cylinder using additional fixing straps.
- To avoid damage to the trace heater, make sure that the fixing straps are not tightened too firmly. It should be possible to move the trace heater slightly under the fixing straps.
- The distances between the fixing straps should not exceed 250 mm.

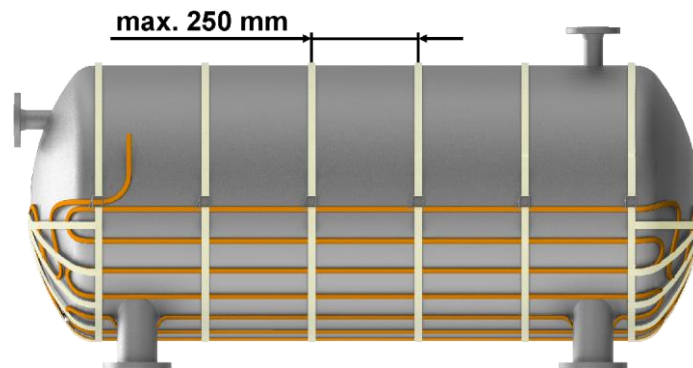

19

- Finally, place aluminium tape on areas of loose contact of the trace heater.
- This Step improves heat transfer and prevents insulating material being trapped between the trace heater and the tank.

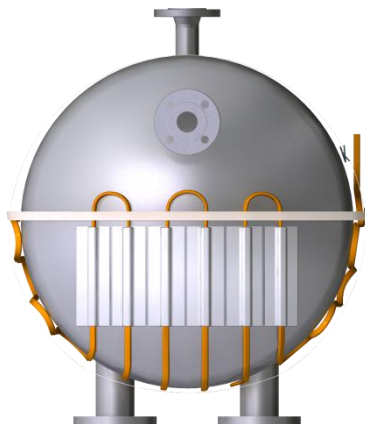

20



## Tests and commissioning

### Measurement of the insulation resistance

The measurement of the insulation resistance is used to determine damage to the trace heater and possible installation faults. It must be carried out at the following times:

- Preliminary test (on the reel, before installation of the trace heater on the construction site; refer to section Acceptance report / Record of inspection on page 19, Test 1 only)
- Acceptance test (after installation of the heating circuit and before installation of the thermal insulation; refer to section Acceptance report / Record of inspection on page 19)
- Final inspection (immediately after completion of work on the thermal insulation)
- Upon commissioning
- Before switching on the installation

#### Preparation of the measurement:

- De-energize the heating circuit.
- Disconnect the thermostat or controller, if installed.
- Disconnect the bus wires and PE wires from the terminal block, if installed.
- For the measurement you will need a megohmmeter with, at least, a minimum testing voltage of 500 Vdc and a maximum testing voltage of 2500 Vdc.

#### Test 1 - Conducting the measurement between the bus wires and the grounding braid:

- Set the test voltage to 0 Vdc.
- Connect the negative (-) lead of the megohmmeter to the grounding braid of the trace heater.
- Connect the positive (+) lead of the megohmmeter to both trace heater bus wires simultaneously.
- Turn on the megohmmeter and set the voltage to 500 Vdc.
- Apply the voltage for 1 minute. The meter reading should stabilize. Rapid changes in the reading indicate a breakdown of the insulation.
- Record the insulation resistance value in the Acceptance report / Record of inspection
- Repeat the measurement at 1000 and 2500 Vdc.

#### Test 2 - Conducting the measurement between the grounding braid and PE:

- Repeat the measurement between the grounding braid and PE (again, at 500, 1000 and 2500 Vdc).

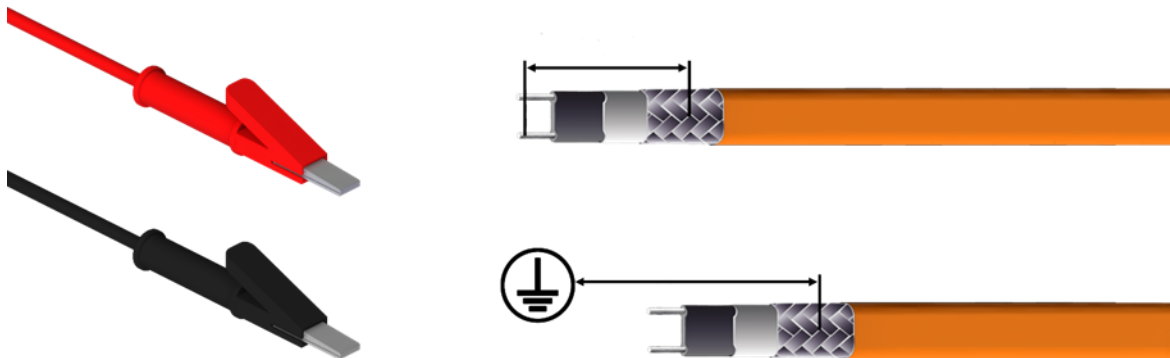

#### Results:

- Properly installed dry and clean trace heater sets should measure thousands of megohms, regardless of the trace heater length or measuring voltage (0-2500 Vdc). Even if optimum conditions may not apply, all insulation resistance values should be greater than the IEC 60079-30-2:2015 minimum recommendation of 20 megohms. However, BARTEC strongly recommends a minimum reading of 1000 megohms. If the reading is lower or fluctuating, refer to section Troubleshooting on page 18.
- Insulation resistance values for Test 1 and 2; for any particular circuit, should not vary more than 25 percent as a function of measuring voltage. Greater variances may indicate a problem with your trace heating system; confirm proper installation and/or contact your local BARTEC representative for assistance.

## **⚠ WARNING**

**Risk of fire or electrical shock. If the insulation resistance is insufficient you must fix the heating circuit before putting it into operation.**

#### After the measurement:

If trace heater meets all resistance criteria:

- Reconnect the bus wires and PE wires to the terminal block.
- Reconnect any thermostat or controller.
- Reenergize the circuit.

**Acceptance test and acceptance report**

- After completion of the installation work (before installation of the thermal insulation) each heating circuit must be accepted, if possible in the presence of the client.
- All further tests must also be documented in an acceptance report (refer to section Acceptance report / Record of inspection on page 19).

**NOTICE**

**Claims under warranty will not be considered if the acceptance report is not filled in completely.**

- After completion of work on the thermal insulation final inspection and acceptance of the individual heating circuits is recommended. Usually, this is the task of the client or the final customer (= final inspection).

**Commissioning**

Each heat tracing system can only be put into operation if the following conditions are fulfilled:

- The acceptance reports for each heating circuit are complete and the trace heating system has been accepted.
- All components of the heating circuit are completely installed and are in working order.
- It has been ensured that the heating circuit is operated in conformance with the technical data specified by BARTEC.

**NOTICE**

**Upon a cold start, additional heating power is required for heating up tanks and pipes. When starting the system you should allow sufficient time for heat up. For further information on heat up calculations contact your local BARTEC representative.**

**Operation**

During operation of the electric trace heating system you must ensure that all components of the system are operated within the operating data specified by BARTEC.

This applies particularly to observation of the maximum temperature. Operation within these operating data is a precondition for possible later warranty claims.

**System documentation**

Complete documentation must be carried out for each system, from the project planning stage, through installation and commissioning up to periodic maintenance of the trace heating system.

This documentation should include the following:

- Project planning documents
- Manuals of all of the components of the heating system
- Heat loss calculation
- Selection of the trace heater
- Layout plans with division of heating circuits
- Circuit graphs
- Acceptance reports
- Reports on repairwork and any operations carried out on the tank/pipe system, trace heating system and thermal insulation
- Inspection reports

**Maintenance****Visual and functional inspection**

- Regularly check the thermal insulation for possible damage, missing seals, cracks, damage to the outer jacket, missing thermal insulation bushings for trace heaters and cables, penetrated water or chemicals. If the thermal insulation is damaged the trace heater should be checked for possible damage.
- Damaged trace heaters must be replaced.
- Parts subject to wear must be replaced (e.g. seals, locking plates etc).
- Check junction boxes, splices, end terminations etc. for corrosion and possible mechanical damage. Make sure that all enclosure covers are properly in place.
- If present, check the temperature controller connecting cables and sensors for damage and that their installation is protected against mechanical damage.

## Electrical inspection

- Measurement of the insulation resistance should be seen as a permanent part of regular maintenance. For instructions on how to perform the test refer to section Measurement of the insulation resistance on page 15.
- After completion of the maintenance, repair or modification work, the insulation resistance of the trace heating system must be measured and noted in the system documentation.

## Inspection intervals

- For frost protection installations inspections should be carried out annually before the heating period begins.
- For systems designed to maintain process temperatures, inspections should be carried out at regular intervals, but at least twice a year.

## Personnel training courses

- Regular maintenance should be carried out by trained, experienced maintenance personnel.
- It is recommended that maintenance personnel is updated on new developments in application technology and maintenance.

## Repairwork on piping or thermal insulation

- Ensure that all safety procedures and precautions in the area for repairs are followed.
- Take care that the heat tracing system is not damaged during repairwork on the pipes or insulation.
- After completion of the repairwork:
  - Make sure that any repaired heating circuits are properly installed and tested according to the project planning documentation.

## WARNING

**Risk of fire or electrical shock due to damaged components. Remember that self-regulating trace heaters are designed to be installed only once.**

- Carry out a visual, functional and electrical test (refer to section Tests and commissioning).

<b>Troubleshooting</b>
------------------------

Problem	Possible cause	Remedy
Trace heater remains cold	No power supply	Check the power wiring for continuity to circuit breaker.
	Trace heater bus wires or power wiring not properly connected	Connect the trace heater and power wiring according to the installation instructions.
	Control unit adjusted incorrectly	Adjust the control unit according to the installation instructions.
Automatic circuit breaker tripped	Automatic circuit breaker defective	Replace the automatic circuit breaker.
	Automatic circuit breaker has wrong tripping characteristics, e. g. "B" instead of "C"	Install an automatic circuit breaker with Type-C tripping characteristics or contact the factory for Type-B tripping characteristics.
	Nominal circuit breaker size is insufficient	Install an automatic circuit breaker with higher capacity. Observe the maximum amperage of all components of the trace heating circuit!
	Maximum heating circuit length has been exceeded	Split the heating circuit into separate circuits.
	End seal has not been installed	Install the end seal according to the installation instructions.
	Short circuit	Identify the cause and remedy the fault (e. g. ensure that trace heater bus wires are not twisted together).
	Humidity inside the connection system or end seal	Dry the components. For junction boxes, be sure that the cable gland is correctly installed and sealing properly.
Ground fault protection is disengaged	Trace heater damaged	Replace the trace heater at the point where it is damaged.
	Moisture in the components	Dry the components. For junction boxes, be sure that the cable gland is correctly installed and sealing properly.
	Ground fault protection defective	Replace the ground fault protection device(s).
Low or inconsistent insulation resistance	Trace heater damaged	Replace the trace heater at the point where it is damaged.
	Moisture in the components	Dry the components. For junction boxes, be sure that the cable gland is correctly installed and sealing properly.
	Arcing due to damaged trace heater insulation	Replace the trace heater at the point where it is damaged.
	Arcing due to inadequate stripping distance between heating element and grounding braid	Check the stripping distance between bus wires//heating element and grounding braid at all power, splice and end seal connections to ensure adequate separation.
	Short-circuit between the grounding braid and the heating element or the grounding braid and the pipe	Check for cut or damaged cable or inadequate stripping length.
	Test leads touching the junction box	Relocate test leads and retest.

*Note: High pipe temperature may lower the insulation resistance reading relative to earlier readings on a cold pipe.*

**Acceptance report / Record of inspection**
**Protocol type**

Inspection before commissioning <input type="checkbox"/>	Inspection after modification <input type="checkbox"/>	Periodic inspection <input type="checkbox"/>
Visual inspection <input type="checkbox"/>	Close inspection <input type="checkbox"/>	Detailed inspection <input type="checkbox"/>

**Project information**

Project / Customer	
Order Comm. No. / BARTEC Order No.	
Date	

**Installation details**

Heating circuit type	Electric Trace Heating of Pipes <input type="checkbox"/>	Electric Trace Heating of Tanks/Vessels <input type="checkbox"/>
Ex version	yes <input type="checkbox"/> no <input type="checkbox"/> Zone <input style="width: 50px;" type="text"/>	Temperature class T <input type="checkbox"/> Ex group <input style="width: 50px;" type="text"/>
Switchgear / Distribution panel	Included in the scope of delivery	UV Name ESS/LDP
	yes <input type="checkbox"/> no <input type="checkbox"/>	Test report <input type="checkbox"/>
Thermal insulation	Thermal insulation material	Thermal insulation thickness in mm (inch) <input style="width: 50px;" type="text"/>
	Check <b>before</b> installation of the insulation Date / Name / Signature	Check <b>after</b> installation of the insulation Date / Name / Signature

**Heating circuit data**

Heating Circuit No.	Sub-Heating circuit			Pipe-/Vessel No.			Building					
	yes <input type="checkbox"/>	no <input type="checkbox"/>		yes <input type="checkbox"/>	no <input type="checkbox"/>		yes <input type="checkbox"/>	no <input type="checkbox"/>				
Product												
Trace heater type												
Lot No. of trace heater												
Trace heater length	<input style="width: 80px;" type="text"/> m	<input style="width: 80px;" type="text"/> m	<input style="width: 80px;" type="text"/> m	<input style="width: 80px;" type="text"/> m	<input style="width: 80px;" type="text"/> m	<input style="width: 80px;" type="text"/> m	<input style="width: 80px;" type="text"/> m	<input style="width: 80px;" type="text"/> m	<input style="width: 80px;" type="text"/> m			
Serial No. connection kit												
Serial No. junction box												
Voltage	<input style="width: 80px;" type="text"/> V	<input style="width: 80px;" type="text"/> V	<input style="width: 80px;" type="text"/> V	<input style="width: 80px;" type="text"/> V	<input style="width: 80px;" type="text"/> V	<input style="width: 80px;" type="text"/> V	<input style="width: 80px;" type="text"/> V	<input style="width: 80px;" type="text"/> V	<input style="width: 80px;" type="text"/> V			
Current (Switch on / operation)	<input style="width: 80px;" type="text"/> / <input style="width: 80px;" type="text"/> A	<input style="width: 80px;" type="text"/> / <input style="width: 80px;" type="text"/> A	<input style="width: 80px;" type="text"/> / <input style="width: 80px;" type="text"/> A	<input style="width: 80px;" type="text"/> / <input style="width: 80px;" type="text"/> A	<input style="width: 80px;" type="text"/> / <input style="width: 80px;" type="text"/> A	<input style="width: 80px;" type="text"/> / <input style="width: 80px;" type="text"/> A	<input style="width: 80px;" type="text"/> / <input style="width: 80px;" type="text"/> A	<input style="width: 80px;" type="text"/> / <input style="width: 80px;" type="text"/> A	<input style="width: 80px;" type="text"/> / <input style="width: 80px;" type="text"/> A			
Output power trace heater	<input style="width: 80px;" type="text"/> W/m	<input style="width: 80px;" type="text"/> W/m	<input style="width: 80px;" type="text"/> W/m	<input style="width: 80px;" type="text"/> W/m	<input style="width: 80px;" type="text"/> W/m	<input style="width: 80px;" type="text"/> W/m	<input style="width: 80px;" type="text"/> W/m	<input style="width: 80px;" type="text"/> W/m	<input style="width: 80px;" type="text"/> W/m			
Trace heater resistance	<input style="width: 80px;" type="text"/> Ω	<input style="width: 80px;" type="text"/> Ω	<input style="width: 80px;" type="text"/> Ω	<input style="width: 80px;" type="text"/> Ω	<input style="width: 80px;" type="text"/> Ω	<input style="width: 80px;" type="text"/> Ω	<input style="width: 80px;" type="text"/> Ω	<input style="width: 80px;" type="text"/> Ω	<input style="width: 80px;" type="text"/> Ω			
Insulation resistance at ..... V (Test 1)	> <input style="width: 80px;" type="text"/> MΩ	> <input style="width: 80px;" type="text"/> MΩ	> <input style="width: 80px;" type="text"/> MΩ	> <input style="width: 80px;" type="text"/> MΩ	> <input style="width: 80px;" type="text"/> MΩ	> <input style="width: 80px;" type="text"/> MΩ	> <input style="width: 80px;" type="text"/> MΩ	> <input style="width: 80px;" type="text"/> MΩ	> <input style="width: 80px;" type="text"/> MΩ			
Insulation resistance at ..... V (Test 2)	> <input style="width: 80px;" type="text"/> MΩ	> <input style="width: 80px;" type="text"/> MΩ	> <input style="width: 80px;" type="text"/> MΩ	> <input style="width: 80px;" type="text"/> MΩ	> <input style="width: 80px;" type="text"/> MΩ	> <input style="width: 80px;" type="text"/> MΩ	> <input style="width: 80px;" type="text"/> MΩ	> <input style="width: 80px;" type="text"/> MΩ	> <input style="width: 80px;" type="text"/> MΩ			
<b>Temperature settings</b>	°C    yes    no			°C    yes    no			°C    yes    no			°C    yes    no		
Controller	<input type="checkbox"/>	<input type="checkbox"/>	<input type="checkbox"/>	<input type="checkbox"/>	<input type="checkbox"/>	<input type="checkbox"/>	<input type="checkbox"/>	<input type="checkbox"/>	<input type="checkbox"/>	<input type="checkbox"/>	<input type="checkbox"/>	<input type="checkbox"/>
Limiter	<input type="checkbox"/>	<input type="checkbox"/>	<input type="checkbox"/>	<input type="checkbox"/>	<input type="checkbox"/>	<input type="checkbox"/>	<input type="checkbox"/>	<input type="checkbox"/>	<input type="checkbox"/>	<input type="checkbox"/>	<input type="checkbox"/>	<input type="checkbox"/>
Low temperature	<input type="checkbox"/>	<input type="checkbox"/>	<input type="checkbox"/>	<input type="checkbox"/>	<input type="checkbox"/>	<input type="checkbox"/>	<input type="checkbox"/>	<input type="checkbox"/>	<input type="checkbox"/>	<input type="checkbox"/>	<input type="checkbox"/>	<input type="checkbox"/>



**Remarks:**

---

	BARTEC Contractor Name / Signature	Customer Name / Signature
--	---------------------------------------	------------------------------

**NOTICE**  
Claims under warranty will not be considered if the acceptance report is not filled in completely.

EC Declaration of conformity

Konformitätsbescheinigung Attestation of Conformity Attestation de conformité N° 01-5850-7C0001_B		
Wir	We	Nous
<b>BARTEC GmbH</b> Max-Eyth-Straße 16 97980 Bad Mergentheim Germany		
erklären in alleiniger Verantwortung, dass das Produkt <b>PSB, MSB</b>	declare under our sole responsibility that the product <b>PSB, MSB</b>	attestons sous notre seule responsabilité que le produit <b>PSB, MSB</b>
<b>Typ 07-5853-****, 07-5854-****</b>		
auf das sich diese Erklärung bezieht den Anforderungen der folgen- den <b>Richtlinien (RL)</b> entspricht  <b>ATEX-Richtlinie 2014/34/EU</b>  <b>RoHS-Richtlinie 2011/65/EU</b>  und mit folgenden Normen oder nor- mativen Dokumenten übereinstimmt	to which this declaration relates is in accordance with the provision of the following <b>directives (D)</b>  <b>ATEX-Directive 2014/34/EU</b>  <b>RoHS-Directive 2011/65/EU</b>  and is in conformity with the following standards or other normative documents	se référant à cette attestation correspond aux dispositions des <b>direct-</b> <b>ives (D)</b> suivantes  <b>Directive ATEX 2014/34/UE</b>  <b>Directive RoHS 2011/65/UE</b>  et est conforme aux normes ou docu- ments normatifs ci-dessous
<b>EN IEC 60079-0: 2018</b> <b>EN 60079-30-1: 2017</b>		<b>EN 62395-1: 2013</b>
Verfahren der EU-Baumuster- prüfung / Benannte Stelle	Procedure of EU-Type Examination / Notified Body	Procédure d'examen UE de type / Organisme Notifié
<b>DEKRA 17ATEX0007 U<sup>(*)</sup></b>		
<b>0344, DEKRA Certification B.V., Meander 1051, 6825 MJ Arnhem, NL</b>		
(*) Die Ex-Komponente ist Teil eines elektrischen Betriebsmittels oder eines Moduls, gekennzeichnet mit dem Symbol „U“, das nicht für sich allein verwendet werden darf und über dessen Einbau in elektrische Betriebsmittel oder Systeme zur Verwendung in explosionsgefährdeten Bereichen gesondert entschieden werden muss.  Merkmale dieser Komponente sowie die Bedin- gungen für ihren Einbau in Geräte und Schutzsys- teme siehe Betriebsanleitung der Komponente.	(*) The Ex-component is a part of an electrical ap- paratus or a module, marked with the symbol "U", which is not intended to be used alone and re- quires additional consideration when incorporated into electrical apparatus or systems for use in ex- plosive atmospheres.  Characteristics and how the component must be incorporated into equipment or protective systems see operation manual of the component.	(*) Le composant Ex est partie de matériel élec- trique ou de module, marquée du symbol « U », ne devant pas être utilisée seule et nécessitant une certification complémentaire lorsqu'elle est in- corporée à un matériel électrique ou à un système pour atmosphères explosives.  Les caractéristiques du composant ainsi que les conditions d'incorporation dans des appareils ou des systèmes de protection regarde voir l'instruc- tion d'emploi du composant.
<b>0344</b> Bad Mergentheim, 25.02.2021		
 i.V. Tobias Gold Head of Business Unit EHT	 i.V. Cristian Olareanu Team Leader Certification Center	
FB-0171d	Seite / page / page 1 von / of / de 1	

EU Konformitätserklärung  
 EU Declaration of Conformity  
 Déclaration UE de conformité  
 № 01-584B-7C0001-C

# BARTEC

Wir	We	Nous
-----	----	------

**BARTEC GmbH**  
 Max-Eyth-Straße 16  
 97980 Bad Mergentheim  
 Germany

erklären in alleiniger Verantwortung, dass das Produkt <b>Selbslimitierende Heizleitung HSB+</b>	declare under our sole responsibility that the product <b>Self-regulating heating cable HSB+</b>	attestons sous notre seule responsabilité que le produit <b>Câble chauffant autorégulant HSB+</b>
--	--	---

**Typ 07-584B-\*\*\*\***

auf das sich diese Erklärung bezieht den Anforderungen der folgen- den <b>Richtlinien (RL)</b> entspricht <b>ATEX-Richtlinie 2014/34/EU</b> <b>RoHS-Richtlinie 2011/65/EU</b> und mit folgenden Normen oder nor- mativen Dokumenten übereinstimmt	to which this declaration relates is in accordance with the provision of the following <b>directives (D)</b> <b>ATEX-Directive 2014/34/EU</b> <b>RoHS-Directive 2011/65/EU</b> and is in conformity with the following standards or other normative documents	se référant à cette attestation correspond aux dispositions des <b>direc- tives (D)</b> suivantes <b>Directive ATEX 2014/34/UE</b> <b>Directive RoHS 2011/65/UE</b> et est conforme aux normes ou docu- ments normatifs ci-dessous
--	--	---

**EN IEC 60079-0:2018**  
**EN 60079-30-1:2017**

**EN 62395-1:2013**

<b>Verfahren der EU-Baumuster- prüfung / Benannte Stelle</b>	<b>Procedure of EU-Type Examination / Notified Body</b>	<b>Procédure d'examen UE de type / Organisme Notifié</b>
--	---	--

**CML 21ATEX31385**

**2776, CML B.V., Hoogoorddreef 15, 1101BA Amsterdam, NL\_**



Bad Mergentheim, 20.04.2023

i.V. Tobias Dold

Head of Business Unit EHT

i.A. Ulrich Mann

Certification Manager  
 Business Unit EHT

EU Konformitätserklärung  
 EU Declaration of Conformity  
 Déclaration UE de conformité  
 N° 01-584C-7C0001-B

**BARTEC**

Wir	We	Nous
<b>BARTEC GmbH</b> Max-Eyth-Straße 16 97980 Bad Mergentheim Germany		
erklären in alleiniger Verantwortung, dass das Produkt <b>Selbstlimitierende Heizleitung            HTSB</b>	declare under our sole responsibility that the product <b>Self-regulating heating cable            HTSB</b>	attestons sous notre seule responsabilité que le produit <b>Câble chauffant autorégulant            HTSB</b>
<b>Typ 07-584C-****</b>		
auf das sich diese Erklärung bezieht den Anforderungen der folgen- den <b>Richtlinien (RL)</b> entspricht <b>ATEX-Richtlinie 2014/34/EU</b> <b>RoHS-Richtlinie 2011/65/EU</b> und mit folgenden Normen oder nor- mativen Dokumenten übereinstimmt	to which this declaration relates is in accordance with the provision of the following <b>directives (D)</b> <b>ATEX-Directive 2014/34/EU</b> <b>RoHS-Directive 2011/65/EU</b> and is in conformity with the following standards or other normative documents	se référant à cette attestation correspond aux dispositions des <b>directives (D)</b> suivantes <b>Directive ATEX 2014/34/UE</b> <b>Directive RoHS 2011/65/UE</b> et est conforme aux normes ou docu- ments normatifs ci-dessous
<b>EN IEC 60079-0:2018</b> <b>EN 60079-30-1:2017</b>		<b>EN 62395-1:2013</b>
<b>Verfahren der EU-Baumuster-            prüfung / Benannte Stelle</b>	<b>Procedure of EU-Type Examination /            Notified Body</b>	<b>Procédure d'examen UE de type /            Organisme Notifié</b>

**CML 21ATEX31388**

**2776, CML B.V., Hoogoorddreef 15, 1101BA Amsterdam, NL\_**

**CE 0044**

Bad Mergentheim, 20.04.2023

  
 i.V. Tobias Dold

Head of Business Unit EHT

  
 i.A. Ulrich Mann

Certification Manager  
 Business Unit EHT



## Limited Product warranty

### Scope

BARTEC warrants that all BARTEC products and accessories that are the subject of this manual will be free from defects in materials and workmanship from and after its date of purchase for a period of 12 (twelve) months.

This limited product warranty does not cover any damage caused by:

- accidents,
- misuse, improper installation, operation, maintenance or repairs,
- neglect, or
- alteration.

Furthermore BARTEC cannot be held liable under this warranty for:

- installation or removal costs,
- loss or damage to property,
- indirect, special, incidental or consequential damages (including, without limitation, loss of revenue or anticipated profits), or
- any other damages or costs directly or indirectly related to the warranty issue.

If all warranty conditions are met (as set forth below), BARTEC will, at its sole discretion:

- repair the product,
- replace the product, or
- refund the purchase price paid for the product.

This warranty gives you specific legal rights, and you may also have other rights which vary by country, state or province. Except as specifically provided otherwise in this limited product warranty, the BARTEC Group General Terms and Conditions shall apply. They are available at: <https://www.bartec.de/en/terms/>

### Specific terms and conditions

BARTEC Global Terms and Conditions are available at: <https://www.bartec.de/en/terms/>

### Conditions

The limited product warranty is subject to the following conditions:

- proper installation, operation and maintenance in compliance with the state of the technology and the product documentation, and
- presence of completely filled in acceptance reports for all installation, maintenance and repairwork operations.

### How to claim the warranty

To file a claim under the limited product warranty:

- Notify BARTEC or your local BARTEC representative by written correspondence or email within 30 days after identification of a possible warranty issue.
- If requested, you must provide any warranty-related information and documentation to BARTEC, including, without limitation:
  - project planning documents, and
  - acceptance reports for installation, operation, maintenance or repairwork.

### Contact

Bartec GmbH, Max-Eyth-Strasse 16, 97980 Bad Mergentheim  
Phone: +49 7931 597-0  
Fax: +49 7931 591-499  
[info@bartec.com](mailto:info@bartec.com)

